

RADIO

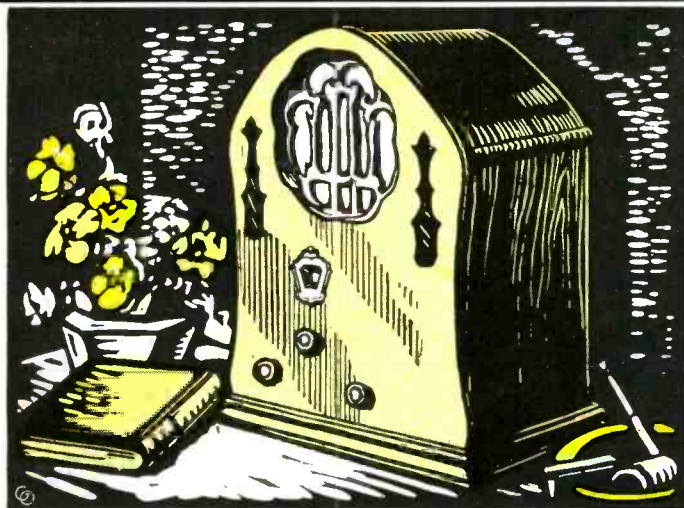

DECEMBER
1930



RADIO
Clarion Jr.

FROM 76TH TO 4TH PLACE
IN CURRENT PRODUCTION
IN 5 MONTHS
THINK IT OVER!

EVERY "BIG-RADIO" FEATURE

TONE CONTROL
NON-OSCILLATING
SCREEN-GRID CIRCUIT

PUSH-PULL 245's
HEAVY DUTY ELECTRO
DYNAMIC SPEAKER

CADIUM PLATED
ALL-STEEL CHASSIS
ILLUMINATED DIAL



Clarion Radio

\$63³⁰

COMPLETE
WITH TUBES

THE GREATEST RADIO VALUE AT ANY PRICE

LET YOUR SERVICE INSTRUMENTS PAY FOR THEMSELVES



Pattern 210 Tube Checker
Gives direct reading on all tubes from UX199 to JX250. List Price \$65.00.
Dealer Price \$48.75



Pattern 199 Set Analyzer
Makes every essential test. List Price \$97.50.
Dealer Price \$73.12.



Pattern 409 Set Analyzer
Gives plate current, and plate, filament, and grid voltages. List Price \$122.50.
Dealer Price \$91.88.

Investigate the



Easy Payment Plan

THE well-equipped radio serviceman gets the business!

Don't delay equipping yourself for efficient and profitable radio service until you can pay cash for needed testing instruments. Take advantage of the Jewell Easy Payment Plan now extended to servicemen who are alive to the profit-making possibilities of Jewell Service Instruments.

Make a good impression upon your radio clients by coming to

their homes with many snappy looking Jewell Instruments.

Convince your customers that you know your business. Jewell Radio Service Instruments are a badge of intelligent service. They are made in several forms to meet your needs, and are provided with data books containing over 200 set circuits with complete instrument readings for every set. This data service takes the grief out of your radio service.

TO RADIO JOBBERS:

All sales of Jewell Radio Instruments are handled through recognized jobbers. Write for complete Jewell Easy Payment Plan which assures immediate return to jobber without cash investment or endorsement of notes. Get the facts, today!

30 YEARS MAKING GOOD INSTRUMENTS JEWELL SET ANALYZERS

Mail this coupon for complete information regarding the Jewell Easy Payment Plan. Do it now!

Act Now
for Bigger
Service
Profits

Jewell Electrical Instrument Company,
1642- I Walnut Street, Chicago, Ill.

Please send information on Jewell
Easy Payment Plan for instruments
checked below:

- Pattern 210 Tube Checker
- Pattern 199 Set Analyzer
- Pattern 409 Set Analyzer

Name

Address

RADIO

REG.
U. S. PAT. OFF.

THE NATIONAL TRADE MAGAZINE

« « LAST MINUTE NEWS FLASHES » »

UNITED STATES RADIO & TELEVISION CORPORATION announces the new *Gloritone* Model 26 midget radio at \$49.95, complete with tubes. It has three screen grids; electro-dynamic speaker and oval-shaped top midget cabinet.

GRIGSBY-GRUNOW announced a new midget set, Model 31, on December 4. The list price is \$79.50, complete with *Majestic* tubes. The cabinet is somewhat similar in appearance to that now used for the present low-priced *Majestic* receiver super. 2,000 of these models are now being produced daily. The new *Majestic* 31 uses three screen grid tubes. It has push-pull '45 audio. Only two control knobs are on the panel, one for tuning and a new combination volume control and "on-off" switch.

CROSLEY adds another small radio to its line. It is called the "*Classmate*." Console model with electro-dynamic speaker and three screen grid tubes. 35" high, 20 $\frac{5}{8}$ " wide, and 12 $\frac{1}{4}$ " deep. Retail price is \$85.50, complete with tubes.

BRUNSWICK RADIO CORPORATION has invaded the English market by taking over the former factory of the Cliftofone Record Company. This plant, although completely equipped, was never put into operation due to financial difficulties. The plant was bought during the first week of October and although reorganized entirely, within six weeks, it was in full operation at the end of this period running at capacity, 24 hours a day. Mr. Joseph Bishop, one of the chief engineers at the Brunswick-Muskegon plant is temporarily in charge of this new operation of the Warner-Brunswick alliance. Record manufacturing is proceeding now on the basis of a yearly output of five million records, the factory doing its own grinding and having its own galvano plant.

ATWATER KENT announces a new and complete unit equipment for centralized control radio installations, particularly for use in schools and other public institutions. Included in the equipment is a switch panel and a monitor JB speaker. In addition, there is also included from one to fifteen extra JB speakers, which can be placed in any location. Junction box, cable assembly system and output transformer go with the unit as a complete assembly. The unit has been designed to be used in connection with Models L, H, F or P chassis only. The model 75 phonograph-radio combination is recommended for multiple speaker installation, as it allows the use of records when good radio reception is not available.

RCA RADIOLA DIVISION announces a device by means of which a radio receiver located at a distance from the listener is automatically tuned to the desired stations by merely pressing buttons. This device is incorporated in two new Radiola super-heterodyne receivers. It includes a duplicate set of push buttons on the radio panel that also permit automatic tuning at the receiver itself.

ARCTURUS RADIO TUBE COMPANY has developed a new type 124 screen grid tube that reduces hum to a minimum when operated as a detector in conjunction with high-gain audio-frequency amplifiers. Patented filament insulation having high resistance at high temperature is used. The new tube acts in 7 seconds.

MOST MIDGET SET MANUFACTURERS in Los Angeles have temporarily stopped production in preparation of new low-priced super-heterodyne receivers. The *Flint* Super-Heterodyne is the first to be announced from the city where the midget set business was born. It is an 8 tube receiver, with '45 tubes in push-pull. Dynamic speaker. Tone control. List price, \$79.50, complete with tubes.

SENTINEL decides to discontinue manufacture of present line of radio sets and *Sears Roebuck's* Chicago store advertises *Sentinel* sets for sale at \$49.75 without tubes.

CROSLEY announces a four-tube screen grid midget to retail at \$37.50 complete with tubes. This is approximately 25 per cent below present lowest prices of midget sets by any manufacturer with national distribution. The new midget is called the "*Elf*." It has two screen grid tubes, one '45 and one '80. Powel Crosley, Jr., says that this new midget greatly enlarges the radio market.

GENERAL MOTORS RADIO CORPORATION is about to release the "*Little General*" clock type radio.

THE ROLA COMPANY, manufacturer of electro-dynamic speakers at Oakland, California, and with a factory at Cleveland, advises that the U. S. Supreme Court has decided that *Rola* has not infringed the patent of the Lektaphone Corporation on cone-shaped loud speakers. H. S. Tenny, president of *Rola*, states that this decision will save his company \$500,000.00 a year.

RADIO

Established 1917

Reg. U. S. Pat. Office

PUBLISHED ON THE FIRST OF EACH MONTH
AT 428-430 PACIFIC BLDG., SAN FRANCISCO, CALIF.

HECKERT L. PARKER - - - Merchandising Editor
P. S. LUCAS - - - Associate Editor
H. W. DICKOW - - - Business Manager
FRANK C. JONES - - - Technical Adviser
A. I. RIVETT - - - Draughtsman

BRANCH OFFICES—

NEW YORK: 415 Lexington Avenue
Phone Murray Hill 5992

CHICAGO: 307 North Michigan Avenue
Phone State 6079

BOSTON, MASS.: 86 St. Botolph Street
Phone Commonwealth 4873

Subscription Price, \$2.00 per year in U. S. and Canada.
\$3.00 in Foreign Countries. Entered as second-class matter
at Post Office at San Francisco, Calif.

CONTENTS for December, 1930

	PAGE
Scraping Bottom	17
<i>By Arthur Hobart</i>	
The Right Way to Make Change.....	19
<i>By John T. Bartlett</i>	
Ideas for Selling More Tubes.....	20
<i>By P. S. Lucas</i>	
The Trend of Radio Merchandising.....	21
<i>By H. C. Grubbs</i>	
What Radio Salesmen Should Know About Broadcasting	22
<i>By Heckert L. Parker</i>	
Selling Radio by Recorded Music.....	25
Sales Quotas	26
<i>By William E. Koch</i>	
Radiatorial Comment	28
Meet the Wife.....	29
<i>By Leon W. Gabel</i>	
News of the Radio Industry.....	31
New Radio Equipment.....	32
Association News	33

A Suggestion to the Reader:

After reading this December number of RADIO give it to someone else in the trade who might be interested in it. Even if he is your competitor, remember that the safest competitor is an educated one. RADIO is teaching better sales and service methods. But if you want to keep this number yourself, send the name of the man whom you think it would help and the publishers will send him a free sample copy.

VITROHM RESISTORS



Quantity — One

If your resistor requirements are modest in quantity, and if you have been using home-made or other resistors because the question of cost deterred you from using the best, we would appreciate quoting on your requirements.

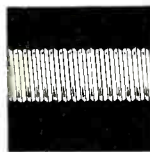

The pitchrod determines the accuracy of winding wire on tubes

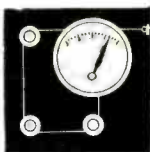

The tension of the wire must be correct



Lack of accuracy in pitch or tension will cause shorted turns or

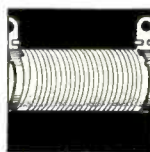

If a perfect winding like this is to result



"Swimming" of wire after one coat of enamel is fused on



Control of these factors is perfect. Two wire sizes are often wound on one tube.

A million VITROHM  RESISTORS are made one at a time. Each individual resistor is carefully wound, thoroughly protected with enamel, and accurately tested. Each resistor is truly "hand-made" with all

advantages of large production. May we receive your next order of "Quantity — One"?

WARD LEONARD ELECTRIC CO.

Mount Vernon, New York

resistor specialists for more than 39 years

FOUR-PILLAR TUBES . . . OR TWO?

WHEN THE RADIO-PUBLIC HEARS THE
DIFFERENCE AND SEES THE REASON, THE
VOTE IS OVERWHELMING FOR FOUR

WHAT'S under the glass? *There* is the vital difference in tubes. Eveready Raytheon Tubes have **FOUR** pillars supporting the fragile elements within the glass . . . **FOUR** points of support, instead of two. The stability of 4-legged Eiffel Tower, let us say, compared to the wobbly structure of the 2-legged goal-posts on a football field.

It all comes down to this: There are 4-Pillar tubes (Eveready Raytheons) and . . . all the others. Eveready Raytheons demonstrate their structural and **SOUND** advantages in the set in the owner's home. National Carbon Company tells you that Eveready Raytheon is here to stay — and grow and grow and grow. It is giving Eveready Raytheon

dealers the same strong support that four pillars give the tube itself.

Talk "four pillars." It's the new and modern thing in tubes, and a winner on every count.

Eveready Raytheons come in all types, and fit the sockets of every standard A. C. and battery-operated radio in present use. Ask your jobber, or write us for names of jobbers near you.

Information and sales-helps, designed for service-men's use, will gladly be sent to you free. Among them is a blue-print, giving engineering data on Eveready Raytheon 4-Pillar Tubes. Thousands of service-men are using this material to advantage. Write our nearest branch.

★ ★ ★

The Eveready Hour, radio's oldest commercial feature, is broadcast every Tuesday evening at nine (Eastern standard time) from WEAJ over a nation-wide N. B. C. network of 27 stations.

NATIONAL CARBON CO., INC.

General Offices: New York, N. Y.

Branches: Chicago Kansas City New York
San Francisco

Unit of  and Carbon
Union Carbide Corporation

**EVEREADY
RAYTHEON**

Trade-marks

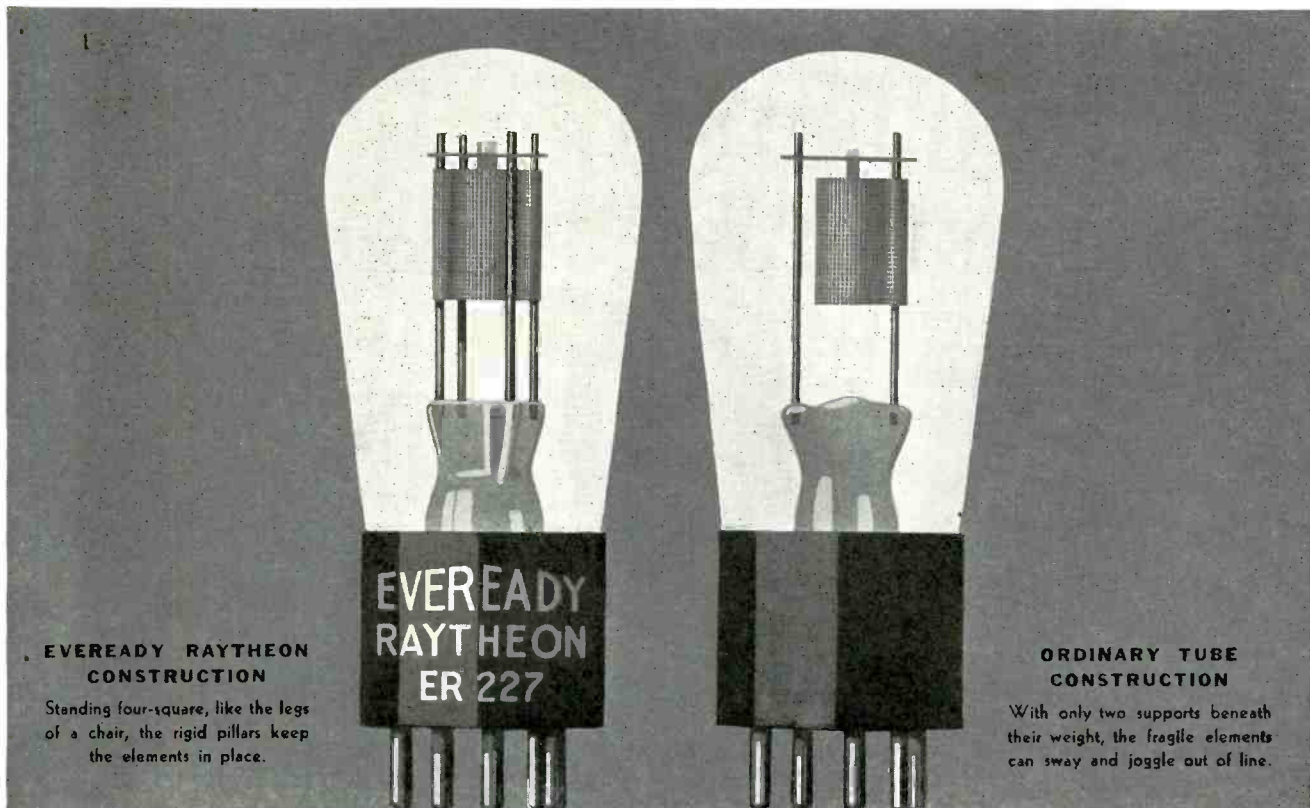

**EVEREADY RAYTHEON
CONSTRUCTION**

Standing four-square, like the legs of a chair, the rigid pillars keep the elements in place.

**ORDINARY TUBE
CONSTRUCTION**

With only two supports beneath their weight, the fragile elements can sway and joggle out of line.

Tell them you saw it in RADIO

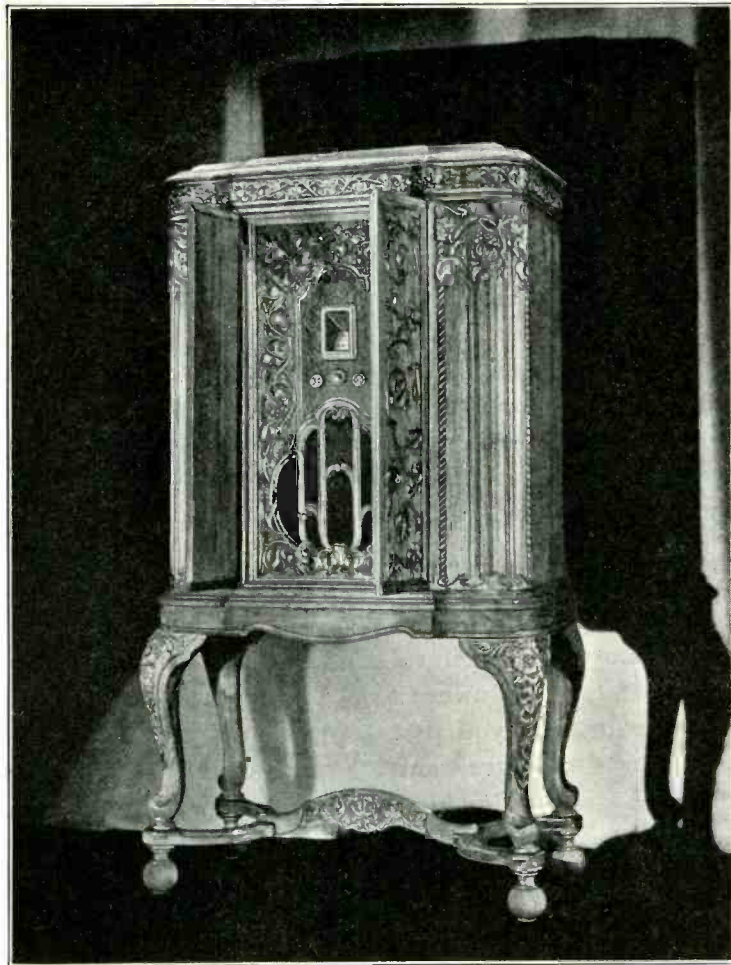

*The highest
note . . .
in radio
achievement*

RADIO

by STORY & CLARK



Wright-DeCoster Reproducers

To be satisfied with nothing short of the finest in craftsmanship and materials has been the guiding principle of Story & Clark since 1857.

What, then, could be more natural than for Wright-DeCoster Reproducers to be selected for the new Story & Clark Radio Model 51 . . . ?



*The Speaker of
the Year*

Wright-DeCoster Reproducers represent the highest achievement in radio reproducing, just as Story & Clark stands for "the highest note in radio achievement."

Such a combination of virtues gives you an unusual opportunity to demonstrate to your customers your understanding and appreciation of both beauty in furniture design and precision in radio manufacture.



WRIGHT-DE COSTER, INC.

2217 UNIVERSITY AVENUE

ST. PAUL, MINNESOTA

Export Department: M. SIMONS & SON CO., 25 Warren St., New York.

Cable Address: SIMONTRICE, NEW YORK

acceptance

Sketch from photograph showing a portion of the inquiries received from the first announcement of General Electric Full Range Radio.



THE STUDIO LOWBOY—7-tube, Screen-Grid Receiver, 4 tuned circuits, Power Screen-grid detector, push-pull audio, new type dynamic reproducer—compact in size. Handsome curved front cabinet. List Price \$112.50 less tubes. Tone Control \$5.00 extra.

THE LOWBOY—9-tube, Screen-Grid Super-Heterodyne. Fitted with local-distant switch. Brown walnut cabinet, satin finished. Early American design. List Price \$142.50 less tubes. Tone Control \$5.00 extra.

Both trade and public are loud and unstinted in their praise of

GENERAL ELECTRIC FULL RANGE RADIO

The first rumor that the name General Electric was to appear on a radio set brought a flood of inquiries—and even definite requests for dealer appointments, and actual orders for sets. From that moment public interest has grown apace. With the appearance of the actual sets, a wave of enthusiasm burst over the trade. That enthusiasm grows daily greater. The performance of General Electric Full Range Radio, the ample advertising support, and the apparently endless interest and acceptance of the public assure a profitable season for General Electric Radio dealers. A year that marks a new era of stability, permanence, and successful business. The following extracts from the General Electric Radio mail-bag tell what the trade thinks of the General Electric Radio:

"This set far surpasses anything we have heard."

"Are more than pleased with the public acceptance and feel more than sure of the best radio season we have had since we have been in the business."

"I, and all that have been in my shop to hear the Lowboy I have on my floor think it is wonderful, and I may add that it is the envy of other radio franchise holders."

"It's just what I have been looking for, for the last seven years."

"It is the first time any radio set I have had has more than lived up to what was claimed for it."

"I must admit, however, that it is really beyond my expectations and my dreams."

"I am thoroughly convinced that this is the best radio that I have ever listened to."

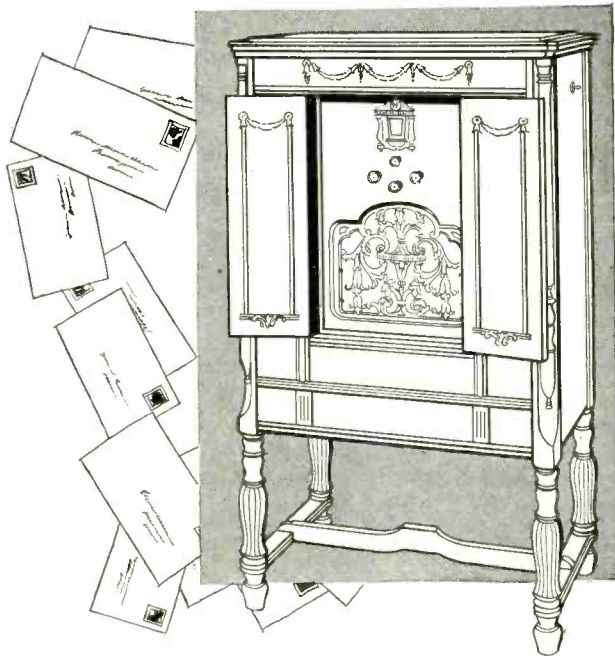

THE RADIO-PHONOGRAPH COMBINATION—9-tube, Screen-Grid Super-Heterodyne. Local-distant switch, tone control and home recording equipment including microphone, 4 blank records and 2 special needles. Brown walnut cabinet, satin finish. List Price \$285 less tubes. Remote control available at additional cost.

THE HIGHBOY (as illustrated)—9-tube, Screen-Grid Super-Heterodyne, fitted with local-distant switch and tone control. Remote control available at additional cost. Brown walnut cabinet with French doors. List Price \$179.50 less tubes.

MERCHANDISE DEPARTMENT R-10212

GENERAL ELECTRIC CO.

BRIDGEPORT, CONN.

Tell them you saw it in RADIO

OPENING PROFITABLE FIELDS FOR

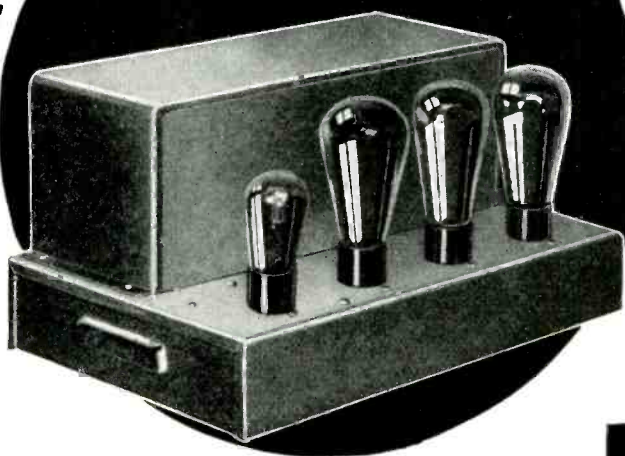

MORE BUSINESS

GET INTO SOUND AMPLIFICATION. Every motion picture theatre, hotel, apartment house, church, hospital, school—as well as riding academies, skating rinks, civic centers—is a logical user of broadcasting and phonograph entertainment. And the equipment used is based on the same fundamental principles which govern radio. *Sell the equipment—make the installations. It means bigger units of sales and bigger profits for you.*

THORDARSON Power Amplifiers provide the foundation for efficient sound distribution systems. They combine all the features of design gathered by years of research and experience in Thordarson laboratories. Consult us freely. Write today for complete descriptive literature.

DISTRIBUTORS OF THORDARSON AMPLIFIERS

- | | |
|---|---|
| Boston, Mass.
Woodrow Radio Co.
166 Prospect Street
Cambridge, Mass. | Minneapolis, Minn.
Jalisco Mfg. Co.
229 E. Hennepin Avenue |
| Chicago, Ill.
Newark Electric Co.
226 W. Madison Street
Chicago Radio Apparatus Co.
415 S. Dearborn Street | Philadelphia, Pa.
M & H Sporting Goods Co.
512 Market Street |
| Cleveland, Ohio
M & M Co.
500 Prospect Avenue | Pittsburgh, Pa.
Cameradio
430 Wood Street |
| Dayton, Ohio
Burns Radio Co.
12-20 Jefferson Street | Seattle, Wash.
Wedel Co.
520 2nd Avenue |
| Minneapolis, Minn.
Findley Electric Co.
111 S. 6th Street | St. Louis, Mo.
Van Ashe Radio Co.
210 N. 10th Street |
| | St. Paul, Minn.
Pioneer Electric Co.
137 E. Fifth Street |

THORDARSON BRANCH OFFICES

- | | |
|-----------------------|---|
| ATLANTA, GA. | Mr. Brower Murphy, 441 Seminole Ave., N. E. |
| BOSTON, MASS. | W. B. Pray Sales Co., 261 Franklin Street |
| DALLAS, TEXAS | Mr. G. G. Willisom, 107 S. St. Paul Street |
| LOS ANGELES, CALIF. | Mr. J. J. Perlmut, 443 S. San Pedro |
| MINNEAPOLIS, MINN. | Mr. M. K. Franklin, 208 Baker Building |
| NEW YORK CITY, N. Y. | Mr. B. J. Aplin, 545 Fifth Avenue |
| SAN FRANCISCO, CALIF. | Mr. W. I. Otis, 905 Mission Street |
| WASHINGTON, D. C. | Mr. Kenneth Murphy, 403 Methodist Bldg. |

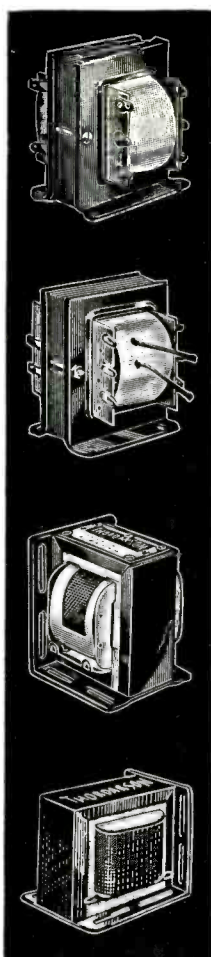

Replacement Power Transformers

T-3381 for single "171" tube in output stage.
T-2971-E for "171" push-pull tubes in output stage.

Replacement Power Transformer

T-3624-E for "245" push-pull tubes in output stage.

Replacement Input Transformer

R-101 for push-pull tubes in output stage.

Replacement Audio Transformer

R-103 for reconditioning radio receivers with obsolete or burned-out audio transformers.

Install tone quality in unsatisfactory sets by replacing inferior, obsolete, or worn out units with THORDARSON REPLACEMENT TRANSFORMERS . . . it is what the set owner hears . . . the improvements in audio amplification . . . that makes pleased customers.

THORDARSON Replacement Transformers are constructed according to the true high standards set by all Thordarson apparatus . . . and they are almost universal in application.

A small stock of THORDARSON Replacement Transformers enables you to recondition a wide variety of sets, with minimum investment in stock. For sale at all good Parts Dealers everywhere. Consult your nearest Thordarson office.

SEND TODAY for the new catalog of Replacement Power and Audio Transformers.

THORDARSON

TRANSFORMER SPECIALISTS SINCE 1895

THORDARSON ELECTRIC MFG. CO. • Huron, Kingsbury, and Larrabee Streets • CHICAGO

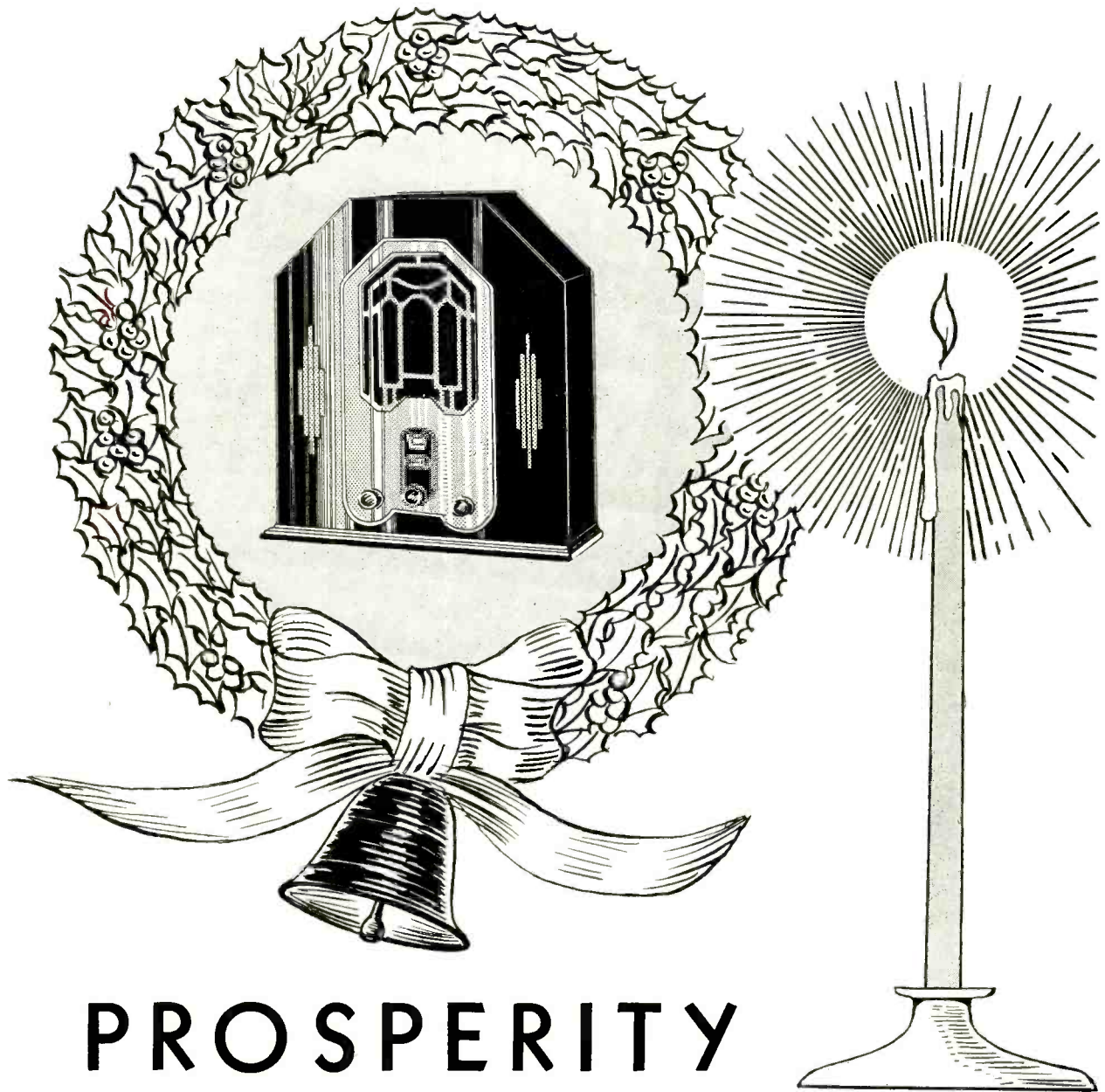

PROSPERITY

CHRISTMAS . . . and the joy of knowing that another year of prosperity is ahead for the Remler Cameo Radio Dealer.

So we pause for a moment to express our gratitude to the large host of Remler dealers whose enthusiasm and confidence in the product has resulted in a season of splendid good business and has brought happiness into the homes of thousands.

RESOLVE now to get on the right side of the ledger during 1931 by selling merchandise that stays sold.

RESOLVE to sell the radio that has stepped squarely into first place in Western sales . . . on sheer merit . . . on quality of tone . . . on **REPUTATION**.

RESOLVE to sell the radio the public wants . . . **REMLER**.

RESOLVE to inquire about the Remler Dealer Franchise and in a year from now you, too, will resolve to renew this resolution.

6 tubes, including 3 screen grid tubes . . . Dynamic Speaker . . . Tone Control . . . Walnut Cabinet.

List Price _____ \$64.50
Complete with Tubes

Gray & Danielson Manufacturing Co.

2101 BRYANT STREET, SAN FRANCISCO, CALIFORNIA

Branch Distributing Depots at

SEATTLE, WASH.
2422 1st Avenue

LOS ANGELES, CALIF.
2704 So. Hill Street

DALLAS, TEXAS
Santa Fe Building

BOSTON, MASS.
North State Building
150 Causeway Street



WINDOW DISPLAYS —ORIGINAL AND ATTRACTIVE



An
Instant
Success

Going like wildfire,
because it's different.

Length 22 inches
Height 17 inches
Depth 6 inches

PATENTED

Interchangeable display card. Your own cards made to order at \$1.00 each.

Illuminated Flashing Billboard in Miniature For Radio Dealer's Window Display Makes Them Stop and Look

\$9.50

This price does not include lamps or display card. Add 50 cents for a set of two lamps and \$1.00 for standard display card as illustration shows.

Sold without sign, but with lamps, for \$10.00. Prices are NET. We sell direct from factory to dealer.

Pays for Itself from One Sale

CROWDS gather at your store window to watch this clever sign flash on and off. Dealers who are now using this Miniature Illuminated Billboard tell us that it is a profitable attention-compelling salesman . . . repeating its message over and over again, politely, quietly and EFFECTIVELY. Beautifully decorated in pleasing color combinations and equipped with automatic flasher that alternately turns billboard lights on and off. Comes to you completely wired and ready to operate from 110 volts, AC or DC. Shipments can be made immediately from stock. Get one of these automatic salesmen and watch your sales curve climb. The cost is so reasonable that even the smallest dealer can well afford to own one.

Send for our catalog of radio lamps and ornaments. They are profitable side lines.

WRITE OR WIRE NOW / CATCH THE HOLIDAY TRADE

Terms: Fifty per cent must accompany order.

Radio Division of

FLORENCE ART MFG. Co.

1401 Folsom Street

San Francisco, Calif.



ANOTHER BEAUTIFUL AUTOMATIC ELECTRIC FLASHER FOR YOUR DISPLAY WINDOWS . . .

The Frog . . . with large, bulging eyes in red. His eyes wink and blink on and off. Put one in your window. Watch the passerby stop and look. Has automatic flasher, intermittently and alternately turning on and off. Finished in Japanese or German Bronze. 14" long, 10" wide. Felt base. This item can readily be sold to your customers.

PRICE . . . \$5.50 NET

**IT'S
POPULARITY
INCREASES
DAILY**



This Record Is **SELLING** RADIO SETS

DEALERS—Increase Your Sales. Demonstrate your radio sets by means of this **TONE TEST DEMONSTRATION RECORD**. It gives the prospect an automatic demonstration of all of the low and high notes in the musical scale—together with short vocal descriptions of what each demonstration means. It's a fascinating and interesting way to convince the prospect that the line of radio sets which **YOU** are selling can pass the **TONE TEST** as recorded on this record. Most of all, it's a **PROFITABLE** way to make more sales. Some dealers have as many as six of these records in use. Get one for yourself—and one for each of your salesmen—**TODAY!**

JOBBERS—Stock these records. Sell them to your dealers. Catalog them. Once the dealer hears this record he will **BUY** it.

SERVICE MEN—This record enables you to make Tone Tests of a receiver before it is placed on the sales floor. A time saver for you—a profit builder for your store.

\$1.00 EACH or a Standard Package of Six for \$5.00
C. O. D. ORDERS TAKEN

"RADIO"

PACIFIC BUILDING
SAN FRANCISCO, CALIFORNIA

Ship..... Tone Test Demonstration

Records at once. I enclose \$
in full payment.

**PRICES—\$1.00 Each—or a standard
Package of Six Records for \$5.00**

Name

Street and Number

City

State

IF C. O. D. SHIPMENT IS WANTED—CHECK HERE

Announcing THE NEW ZANEY-GILL MIDGET

With

VITATONE

AMAZING! NEW! STARTLING!

FROM the laboratories of ZANEY-GILL comes this new, remarkable Midget receiver, incorporating all the engineering refinements resultant of over a year's continuous Midget building.

A perfected product of a pioneer in this field, which has revolutionized today's radio industry.

Introduced nationally at the Atlantic City show last June, ZANEY-GILL'S Midgets now operate in all parts of the United States and in 27 foreign countries—a joke to the industry in June, and the most serious thing in radio this Christmas.

1 TUBE EQUIPMENT. Three 224, one 227, one 245 and one 280. Equipment includes phonojack, long and short aerial control, connection for home broadcasting, television amplification and safety equipment to comply with the underwriters, including fuse protection from 100 to 135 volts.

2 CABINET. Of hand picked figured walnut veneer, matched and hand rubbed. Soft, harmonious finish, blending with the most fastidious surroundings.

3 SPEAKER. Full 9-inch electro dynamic A.C. operated. Quiet and delivering a full, rich mellow tone, with full range realistic output equal to any receiver at any price.

4 THE DREADNAUGHT CHASSIS. Built like a battleship of cold pressed steel, chromium plated, thoroughly shielded and adapting the newest in chassis construction—the removable head. Designed and engineered "for a Midget"; size 12x7 inches, although small in size, relativity and correctness of design are found in this sensational radio. Sturdiness predominates, enabling full use of the portable feature with this miniature receiver. Although it is small and compact in comparison with other receivers, its wonderful tone, sensitivity, selectivity, volume and distance-getting ability cannot be equalled.



RCA LICENSED

12 REASONS WHY

1. A new tone for Midgets, unbelievable from so small a set—full, rich depth with clearness and realism never before attained in anything near its price. A REVELATION!

2. VITATONE! Supplies the missing dimension in Midget music—DEPTH. No words can explain it, you have to hear it. VITATONE! Also clears the atmosphere, eliminates line noises—opens the channels to clear, pure, realistic melody.

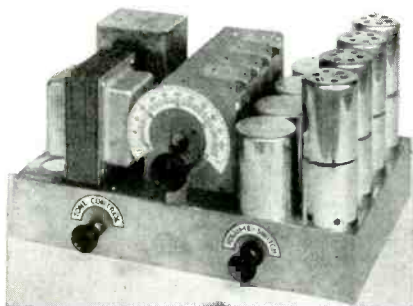

3. DISTANCE! With the new ZANEY-GILL Midget is limited only by your location. Under ordinary conditions coast-to-coast reception is easily obtained with perfect clearness.

4. Four tuned circuits, three stages of screen grid radio frequency amplification and detector.

5. Rugged, FULLY SHIELDED four-gang condenser, wide spaced plates eliminating disalignment in shipping.

6. Pre-tuned antenna circuit giving the very utmost in selectivity plus the elimination of side band cutting, the great cause of distortion in improperly designed circuits.

7. Tone control coupled with "VITATONE" the first real advancement in tone manipulation. It does not cut volume or definition of tone to achieve this.

8. Full vision dial—ILLUMINATED! Vernier control for fine tuning.

9. Full dynamic speaker scientifically baffled—full sized to withstand the auditorium output of VITATONE.

10. Heavy duty oversize power transformer and condenser banks eliminating service grief and replacements.

11. Cabinetry of walnut—hand rubbed and detailed for the most fastidious tastes—a product of Grand Rapids.

12. Chassis of a new silver zinc copper compound developed for this purpose, far superior to steel, fully shielded, sturdy, to withstand rough handling in shipments, compact, and protected in full compliance with underwriters' regulations.

LISTING AT

\$ 49.50
LESS
TUBES
F. O. B.
CHICAGO

Immediate Deliveries Now!

3 SCREEN GRIDS
NEW CHASSIS WITH VITATONE!

Franchise Available Now

WRITE / WIRE / PHONE

ZANEY-GILL CORPORATION

1727 WEST 22ND STREET

CHICAGO, ILLINOIS

CANAL 6727



RADIO is BOOMING

Pick the Job You Want and Fill It...in a Few Months!



*Prepare
at Home*

Only an hour or so a day is all you need. This Big League training prepares you for success in all phases of radio . . . manufacturing, servicing, selling, ship and shore broadcasting, photo-radiograms, radio equipment. Our graduates are now in demand everywhere . . . because they are posted right up to the minute in everything in radio. Radio's progress each year is measured by the accomplishment of the great engineers at work in the research laboratories of the Radio Corporation of America. This world-wide organization sets the standard for the industry . . . and stands back of every lesson in the course! A signed agreement by the president of the school assures you absolute satisfaction upon completion of the training—or your money will be promptly refunded.

By means of an actually proven kind of home study training sponsored by the Radio Corporation of America, hundreds of ambitious fellows are today enjoying financial independence in work that is thrilling.

Radio needs you. Opportunities are begging for men. Good money . . . fascinating work . . . adventure galore! Read all about this tremendous modern industry . . . send for this magnificent free book. Mail the coupon now!

THE ONLY COURSE IN RADIO SPONSORED BY R.C.A.

RCA INSTITUTES, INC.
(A division of
Radio Corporation
of America)



RCA INSTITUTES, Inc.
Dept. R-12
75 Varick St., New York, N. Y.

Gentlemen: Please send me your big FREE 40-page book which tells about the brilliant opportunities in Radio and about your famous laboratory-method of guaranteed radio instruction at home.

Name

Address

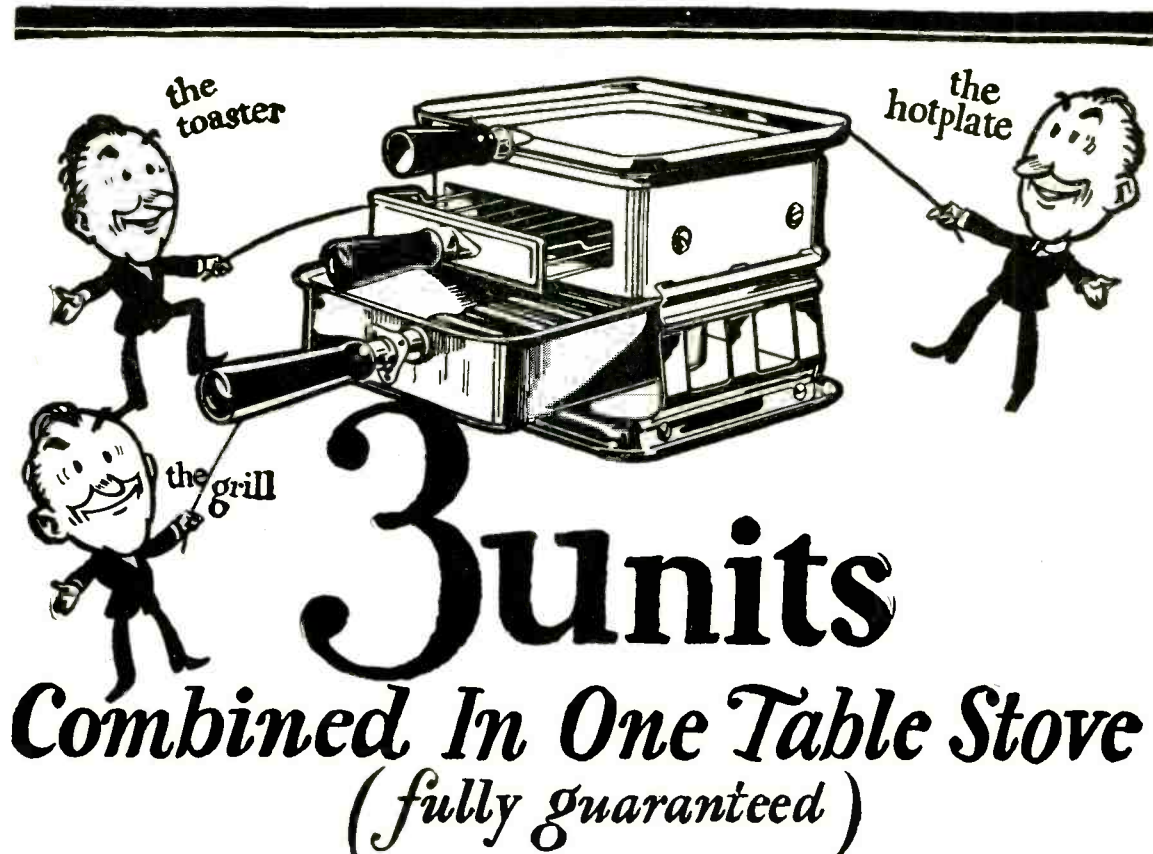

3 Units

Combined In One Table Stove

(fully guaranteed)

**GRILL
HOTPLATE
and TOASTER**

for ~
\$8.85

Grill, hotplate and toaster all combined in one practical Armstrong Table Stove and it operates on the current consumption of an ordinary toaster! And with it come all the solid aluminum utensils necessary to really make it a pleasure to cook right at the table.

Practical—because it means quick breakfasts, wholesome lunches and an interesting and easy way to prepare tasty things for informal entertaining.

Convenient—because the patented two layer element toasts, fries, and broils or grills all at the same time—Cooks Three Things at Once — and does it right at the table.

Economical—because it attaches to any light socket or wall outlet, does the work of 3 or 4 appliances and consumes only the current of any one of them.

The ARMSTRONG Table Stove

THE ARMSTRONG ELECTRIC MFG. CORP'N
HUNTINGTON WEST VIRGINIA



Check These Reasons Why the ARMSTRONG AUTOMATIC RANGE can increase your profits—

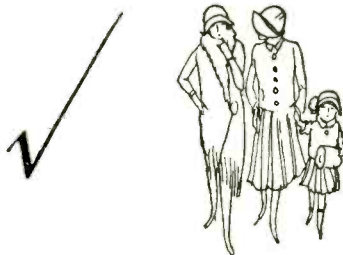

Here is a range that brings women a real freedom from kitchen drudgery—a range that is in keeping with everything beautiful, modern and practical. With an Armstrong Automatic Range the housewife may prepare her evening meal in the morning, place it in the oven, set the clock and forget about cooking for the day. When the family gathers for dinner, everything is ready—beautifully browned roast, deliciously tasty vegetables, all piping hot from the Armstrong oven. To the Modern Housewife this range is not a longed-for luxury, but a practical necessity for economic and efficient household management.

This clever wall mounting will charm the ladies. No more need for legs on a range than for legs on a kitchen sink. Sweeping and mopping are so much easier with this bracket-type mounting.

Every part of the Armstrong Automatic Range is easily accessible for cleaning. The entire range top lifts up for removing crumbs and droppings. The oven is lined with rustless steel and the finish is white enamel with shiny nickel trim.

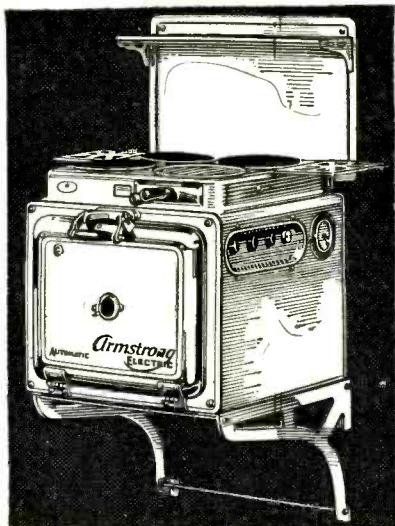

Cooking is a pleasure on the Armstrong Automatic. There is no wasteful escape of heat for it goes into the food directly. One's kitchen never gets hot for the oven is insulated by means of dead-air space which insures economical current consumption and little or no heat lost.

Note the compact arrangement of this range. Takes up about half the kitchen space of the ordinary range yet has full capacity. There are four surface units, one of which is a unique breakfast corner combining toaster, griddle and waffle iron—toast and waffles made without turning. The oven is full-size, too, equipped with white enamel broiler pan and rack with removable broiler and baking elements.

Our Exclusive Proposition

To a worthwhile, aggressive dealer in each community, we are offering a most attractive exclusive proposition on the Armstrong line of modern electric ranges. Backed by our National Advertising Campaign directed to smart American Women, dealers are anxious to tie in with Armstrong and are quick to realize the possibilities this business holds for them. The margin of profit is liberal—the consumer demand already established—the business yours if you will go after it. Identify your organization with a line of quality electric ranges and enjoy your share of the profit.

If you will fill in the attached form, we shall be glad to furnish you with full particulars regarding the Exclusive Distributorship of Armstrong Ranges. Our plan is an unique one, in which we are sure you will be interested.

The Armstrong Electric Mfg. Corp'n

HUNTINGTON

WEST VIRGINIA

Tell them you saw it in RADIO

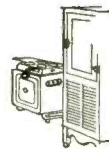

THE ARMSTRONG ELEC. & MFG.
CORPORATION,

101 Seventh Avenue,
Huntington, W. Va.

Gentlemen:

We are interested in your exclusive range policy. Please send full information on all Armstrong Ranges.

Name.....

Address.....

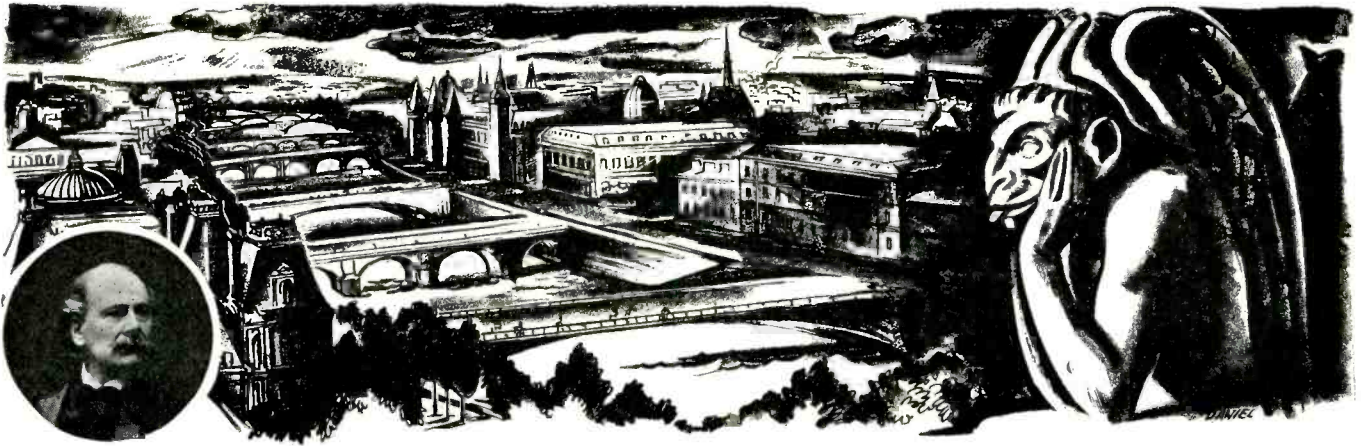

Massenet's opera "Le Jongleur de Notre Dame" was inspired by the great medieval church of Notre Dame whose famous gargoyles still look out over Paris. Brunswick Record 50082.

LOOKING TOWARDS THE FAR HORIZON ♦ ♦ ♦ ♦

A successful business must be conducted with a thought not only for tomorrow, but for the years to come. Retail dealers who are building for permanence will naturally be attracted to a manufacturer who has this end in view.

What better way is there to judge a company than by the way it has acted in past situations? If its course has always been honorable, its choice of conduct upright; it is reasonable to assume that its future actions will always be worthy of the good reputation it has already established.

Brunswick has been in business for many years; it has been building musical reproducing instruments since long before the first radio broadcast started a new industry.

In all its long career Brunswick dealers have never once suffered because of short-sighted merchandising policies. There has never been any compromise when the good name of the company was at stake. Dealers have never been left to hold the bag for mistakes which were not of their causing.

As a result, dealers who are now seeking a stable line of radio and record-playing instruments which they can carry through the years, know that they

can look confidently to the future with Brunswick!

Inquiries from such dealers are invited.

Brunswick Radio Corporation

MANUFACTURERS OF RADIO, PANATROPE & RECORDS

Makers of the World-Famous Brunswick Records

NEW YORK—CHICAGO—TORONTO

SUBSIDIARY OF WARNER BROS. PICTURES, INC.

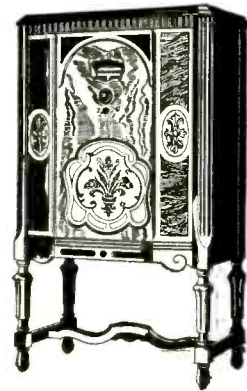

BRUNSWICK LOWBOY MODEL 15

Armored chassis with 4 screen-grid tubes and two 45's in parallel. Uni-Selector and Illuminated Horizontal Tuning Scale. Tone Control. Cabinet of seasoned and selected butt-walnut with carved front panels. **\$139⁵⁰**

Other models \$170 up.

(less tubes)

BRUNSWICK

1 1 1 1 1 1

RADIO FUTURA SERIES FOR 1931

RADIO

The National Trade Magazine

VOLUME XII

DECEMBER, 1930

No. 12

Scraping Bottom

By

ARTHUR HOBART

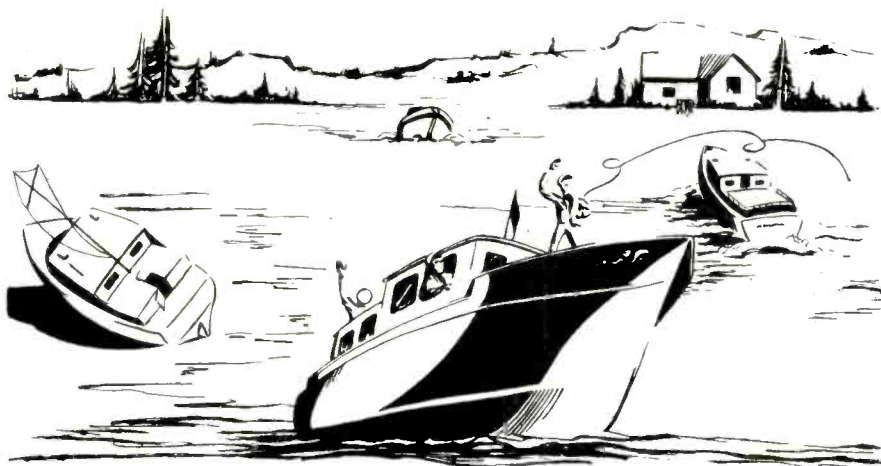

FOR several months, financial optimists have been proclaiming that general business is at last "scraping bottom," meaning thereby that the lowest point has been reached in the present cycle of depression. Yet each succeeding month between June and December has witnessed a further recession from normal business. The present financial waters are uncharted, the soundings are unreliable, and nobody seems to know definitely when the tide will turn.

Yet, in a slightly different sense, many radio businesses are scraping bottom. Some are already high and dry on the tide flats. Some shallow-draft boats are still afloat. Others are in safer waters where there is no danger of scraping bottom even if the tide continues to go out for another year, which is most unlikely.

What does a fisherman do when he feels that his boat is scraping bottom? As a rule he puts his engine into reverse and tries to back into deeper water. Or he may drive full power ahead in hopes that deeper water lies beyond the bar on which he is temporarily grounded. Or he may put his anchor in a tender, row out to deeper water, drop the anchor, return to the boat, pull on the anchor rope, and thus clear himself. Or, finally, he may cease

to struggle and wait till the tide comes in and floats the boat.

This analogy is drawn because it seems to illustrate certain conditions in the radio business today and because it offers several solutions to the problem that faces many radio dealers. Reversing the engine corresponds to cutting the overhead. Driving full power ahead is equivalent to putting forth greater sales effort. Carrying the anchor out to deeper water may be likened to selling a non-radio side-line. Waiting till the tide comes in is the same as using reserve capital to pay operating expenses until general business improves.

For those who can afford to do so, the last named course is the most sensible. It requires patience, it means deprivation if the tide is too long in returning. If the boat has not a flat bottom, i. e., if the business is not stable, it may be damaged by lying on its side. But most boats in the retail radio business are not well enough provisioned to wait until the tide returns.

Some that are already high and dry must be abandoned. Really, there are too many boats anyway, considering the number of fish that are to be caught. A new boat in other less fished waters may be better after all, and the fishing here will be improved for those who remain.

Some of those who are just beginning to scrape bottom can reduce expenses and lighten the load sufficiently so as to continue in business without loss until the radio business comes back next year. Others, by redoubled sales efforts on radio sets alone will be able to keep a big organization going, though with small profit to the owner.

But to the great majority of radio dealers who are now in business, those who either cannot afford to wait, or those who have already cut their overhead to the absolute minimum, or those whose probable sales of radio do not justify the expense of forced selling methods, the most likely "out" is the sale of non-radio equipment for the home. What this might be is the chief purpose of this discussion.

But before considering side-lines, it is profitable for the dealer to consider one other nautical meaning of this "scraping bottom" theme. After any boat has been in salt water for some time it accumulates barnacles which greatly impede its progress. Periodically a boat is put on the ways so that these barnacles can be scraped from the bottom of the hull. Many business have likewise acquired barnacles which must be scraped off before they can make satisfactory progress.

Selling Side Lines

THE sale of non-radio devices has been the salvation of many a radio dealer during the past period of sub-normal radio sales. Dealers who have continued to sell radio as their main line have also sold other specialties. Variety of product in such cases has been not only the spice of life but the actual means of livelihood.

There are many good reasons for this practice and but few against it. Even radio manufacturers are making non-radio devices and radio jobbers are distributing them. They have found that radio dealers are good sales outlets for many different specialties that are used in the modern home.

Radio is still a specialty, rather than a staple. The same intensive selling methods which are used in introducing it can be successfully applied to the sale of other products. Customers who have bought a radio are likely prospects for other home-making devices. Salesmen who have been trained in specialty selling can readily turn their talents to selling other specialties. Likewise the method of financing installment buying of radio can be used in partial payment purchases of a great diversity of other products. Furthermore, a radio man can readily learn how to service other devices which require it.

The Selection of a Side Line

A WIDE variety of non-conflicting products is available. Nor is there anything incongruous in a music dealer's selling an electric refrigerator or in an electrical dealer's selling phonograph records. In fact, with the growing popularity of combination radio and phonograph sets any radio salesman is overlooking a good bet if he does not sell records.

Records are being used to a rapidly increasing degree in demonstrating the tone quality of radio sets. Every dealer should have a representative stock on hand for this purpose. The modern radio set can likewise be used for demonstrating records. They are easily displayed and add but little to the overhead cost of selling.

Closely associated with the sale of records is the sale of phonograph pick-up and recording devices. There is a big potential market for the latter in the case of people who own a radio that is not already equipped for recording as well as reproducing.

The determination as to what other side lines should be handled is governed largely by the general policy of the store and the competitive situation with regard to the device in question. The usual outlets for the sale of radio have a policy of catering either to radio buyers somewhat exclusively, to buyers of musical instruments, or to electrical purchasers. This classification elimi-

nates department stores, whose policy is to sell anything which gives promise of profit, and miscellaneous stores who sell radio as a side line. The competitive situation depends upon whether the existing agencies for the sale of any contemplated device are not already more than adequate so that little sales opportunity is left for the radio dealer.

Furthermore, the article to be sold should be a specialty rather than a staple, not only because radio is also a specialty, but also because specialties carry a sufficient margin of profit to justify intensive selling methods. The market for electric irons, washing machines, vacuum cleaners, and sewing machines, for instance, is so nearly saturated that the greatest volume of sales comes from replacement rather than original installation. Therefore such devices would ordinarily not be considered by any store other than an electric dealer or a home furnishing goods store.

The electric refrigerator is still in the specialty class and offers an inducement that it can be sold at times when radio sales are normally at the lowest ebb. It should be remembered, however, that delivery requires a heavier truck than is ordinarily used to deliver radio sets and that the installation requires two or three men. What little servicing as may be required can be done by a good radio service man.

Somewhat the same comment as to seasonal sales and installation difficulties applies to a lesser degree to electric ranges. Cooking by electricity has a peculiar interest to housewives and lends itself admirably to specialty salesmanship. The radio dealer seems to be a logical outlet for this device, especially if he works in conjunction with an electrical contractor to do the wiring.



Movie Projector and Synchronized Phonograph in Radio Combination Made by Bell & Howell Co.

Many radio dealers are profiting from the demand for electrical clocks. The difficulty here is the competition from almost every other kind of a store which is also selling them. Their popularity is so great that they will soon become a staple. Various electrical devices such as air-heaters or waffle irons are in much the same category; yet they make a good side line in towns where two many other stores do not carry them.

Although not exactly a side line, many dealers have been successful in selling sound amplifying equipment to theaters, auditoriums, stadiums and hotels. This is a highly specialized business that requires expert knowledge both in sales and in installation work.

In localities which are adjacent to navigable waters some dealers have found it profitable to handle outboard motors and even motorboats. Since the highways have become crowded the American public has become boat-minded in its form of recreation. Motor boat owners are also good prospects for the purchase of the new radio sets designed for installation in the automobile.

The ideal side line for the radio dealer, as a purveyor of entertainment in the home, is the home talkie-movie. A number of excellently synchronized models are available but sales have been retarded by the scarcity of synchronized films and records. The same is true of the home movie projectors without sound attachment. Until great circulating libraries of interesting films have been established in every community and until rentals are more reasonably priced, few families can justify the purchase of a projector.

Unless a marked improvement is soon made in this respect the manufacturers will lose this market. Radio movies are not so far distant as some people imagine. With the transmission of synchronized sound and satisfactory pictures from central studios there will be no good reason for renting or buying films and records. Recent revolutionary developments in methods of picture transmission may make possible the marketing of good television sets within a year.

In all probability, however, commercial considerations will retard the introduction of the radio movie. Otherwise, too many apple carts would be upset. Imagine what will happen to the movie industry when one picture film with sound track can be seen and heard through thousands of radio receivers within range of a single broadcast station. The same strategy which dictated that the pentode should not be allowed to destroy this year's market for sets employing three and four-element tubes, may likewise be successful in withholding television.

(Continued on Page 34)

The Right Way to Make Change

By JOHN T. BARTLETT

IT MAY be an accident when a customer receives back too little change, but it is hard for the average customer to believe it. It probably is an accident, too, when a customer is given too much—but many times the money is thrust into a pocket, and no one knows a mistake has been made till checking up reveals that somewhere there was an error, and the store is “out.”

Making change *right* avoids either occurrence. In the accompanying pictures, Harold Stevens, Boulder, Colorado, an expert in store practice, shows the right way.

No. 1. Mr. Stevens holds a five dollar bill in his hands between thumb and forefinger of each, in plain view of the customer. He repeats amount of the sale, \$1.80. Then he states amount of tendered currency, \$5.

This is a decidedly important precaution. If customer has misunderstood amount, or believes he has tendered a bill for a larger amount, right then and there he must offer protest. Retailing experience shows that when this precaution is not taken, cases of dispute over amount of currency tendered are certain to arise—embarrassing to the store, destructive of good will, resulting in actual loss of money in some instances.

No. 2. The expert turns to the cash register. He may, if he feels additional precaution necessary, place the bill upon the ledge. With left fingers he presses keys, and with right punches.

No. 3. He places bill in drawer and counts correct change.

No. 4. The change is counted from ledge to customer—two dimes make two dollars, and three dollars in succession proves the correct count to \$5. Counting of change should be ordinarily, by largest units possible. The customer likes to receive change in this manner; the possibility of error is reduced. Under the routine here described, there is a check on money twice, and possibility of error is reduced close to the vanishing point.

In making change, accuracy comes first. A qualified retail salesman, however, will be rapid, also. The fast making of change comes about through dexterity at the cash register, and fast calculation of change.

With experience, a retail salesman would have at his fingertips, as it were, a great variety of change combinations in the range commonly met in his store. A sale of \$1.90 as he takes change from the drawer, \$5 tendered, means, without any conscious calculation, a dime and either a two-dollar and one-dollar bill, or three one-dollar bills.

The answer should be in the hand, in a way of speaking, to innumerable other arithmetic problems presented by sales.

Rapid making of change is facilitated, also, as there is a store routine which provides each cash register daily, with an adequate “bank.” Suppose a cash register is given a “bank” of twenty dollars.

If experience is watched from day to day, how this \$20 should be divided among the various denominations, so that change-making will be done most efficiently can be determined. The denominations most frequently run out of are the ones, naturally, to be increased in the distribution with which the day started. Denominations commonly in oversupply can be reduced in the same way.



No. 1. Hold bill, repeat amount of sale, and state amount tendered.



No. 2. Press keys and punch cash register.



No. 3. Place bill in drawer and count correct change.



No. 4. Count change as given to customer.

IDEAS *for* SELLING *More* TUBES

By P. S. LUCAS

Too many dealers, and customers also, make the mistake of thinking that a vacuum tube is good as long as it lights. And thereby the dealer loses business from customers who do not realize that a new tube would improve their reception. Therefore, the first rule for getting more business in tubes is for the dealer's salesman to call on every old customer every six months, merely to check the condition of the tubes in the radio set and to demonstrate that new ones give better reception.

If the dealer is truly aggressive he will not limit himself to his own customers, but get acquainted with as many others as possible. And if, in his scouting, he takes a customer away from another dealer who has not shown himself so solicitous after his patron's welfare, he cannot be expected to mourn for his competitor.

It is conceded by every radio dealer that the tube business is always to be relied upon as a friend in need, regardless of hard times. The very causes of the slumps that affect the sales of receivers are often boons to the tube business. Take, for instance, the deplorable dumping of "distress" merchandise. Whether a radio receiver is bought for its list price or on sale for one-half off its owner is going to be an equally good prospect for tubes. The dealer who will not handle "distress" merchandise certainly can have no compunctions about going forth and replacing a set of tubes in the lucky buyer's radio.

He has his choice of several alternatives—hold on until times are better, keep alive on service work and an occasional sale, give up the ghost, or get out after some of the enormous tube business that must follow a terrific unloading campaign. Seldom does the store that does the dumping follow up with an aggressive tube replacement crusade. Usually it spends its entire energies upon the sales floor and in advertising its sales. In most cases inferior tubes are used because of the long discounts, with the result that the customer will be all the more quickly in need of new ones. By this time a great light should be dawning in the mind of the dealer who has been bemoaning the fact that the department stores and others are dumping him out of business.

Tube manufacturers are doing every-

thing within their power to help the dealer sell tubes—naturally. The magazines and newspapers are carrying a great deal of advertising directed at the customer. It is for the dealer to direct his own advertising and sales efforts along the lines chosen by the manufacturers of the tubes he pushes. Hygrade talks of craftsmanship, Eveready Raytheon points to a particular type of construction, R. C. A. Radiotron says, "Old tubes may impair the performance of the new," Arcturus speaks of quick heating. One blames bad tubes for harsh or mechanical programs; loss of pep. Another invites the customer to ask for a free demonstration. A third emblazons the image of the package on the mind's eye. Whatever may be the most consistent appeal of the manufacturer, that should be the nucleus of the dealer's own advertising and sales arguments.

Some manufacturers supply the dealer with plans and matrices for a well formulated local newspaper campaign, which may be followed in whole or in part. Just as in the case of the manufacturer's advertising it must be supplemented by window displays, the use of show cards and other dealer helps, possibly direct mail and/or a house-to-house selling campaign. The dealer should study carefully the manufacturer's dealer advertising and literature that appears in trade journals, house organs, letters and bulletins, so that he may strike the same note in his own advertising and in his sales arguments that the maker does in his messages to the public.

Assuming that the dealer is tying in with the manufacturer's advertising campaign by advertising tubes in the local newspapers, by featuring tubes in his windows, by displaying his stock where it can make the greatest "imprint" (to steal a choice word from Andy) on the customer, and by being prepared to reiterate verbally the message carried in the manufacturer's ads, let us look for the few remaining rungs that complete the ladder to successful tube merchandising.

Selling Direct by Mail

FIRST, there are great possibilities in direct mail. This is an economical form of advertising if properly planned and carried out—and an expensive one if carelessly handled. The nicest point

in its favor is that it can be regulated to fit the budget. The direct mail letter must be well worded; brief and straight to the point. And there must be a point—only one point. Some manufacturers have their advertising departments prepare specimen letters for their dealers. The letter must be attractive in appearance, even as to the envelope, else it will never be opened. And it must always wind up with an appeal for action, such as "Call — and we shall send a man to test your tubes," or "Check and return the enclosed postcard." In the latter case a printed, self-addressed postcard with a business reply stamp should be enclosed in the envelope. The postage for the card is collected from the dealer when and if the card is returned.

A single letter rarely succeeds in bringing results. It requires a lot of hammering to make a sale, and the dealer who becomes discouraged with the results of the first couple of attacks is comparable to the carpenter who blames the hammer or the nail when he finds that two blows won't sink the nail to the head.

Most retailers who use direct mail recommend a letter every two weeks over a period of about six months. It is to be supposed that the prospective customer should be ready for at least one new tube during this time, and that the seventh or the eleventh of the series of letters should still be hanging around when the need makes itself evident. The main purpose of such consistent driving, of course, is to so firmly engrave the dealer's name and message in the prospect's mind that they become the natural reaction to the thought of better reception.

Then there is the matter of lists. The wise dealer will have a list of all his customers in sales and service ever since he has been in business. To supplement this, some resort to the telephone directory, others to the voting register. Both are satisfactory as far as the up-to-date-ness of names and addresses is concerned, but are enormously wasteful because only a certain percentage of the people listed have radio sets.

In the larger communities there are always many special lists on sale; lists of people in certain earning classes, automobile owners, teachers, dentists, and plumbers. There is always a price af-

fixed to such a list, and never any certainty that the list is any better, or as good, as that obtainable from the telephone directory.

One prominent dealer in the West is building himself a splendid list for both tube and receiving set advertising campaigns. He started with the registration lists, organized by location, up one street and down another. Then he sent a man with a tube tester to push door bells. When the man came out of each house he had tested the tubes, informed the prospective customer of their condition, possibly sold a couple, filled out a card with information regarding the type, age and satisfaction given by the radio receiver, or noted the lack of a radio receiver. Once the rounds have been made this dealer will have a list worth more than any other such list available. He can use it for repetitions of the tube testing visits, sales letters for tubes, sets, batteries or any other type of merchandise.

This house-to-house method of getting a list is really incidental to the presumed purpose of the bell-ringing campaign. In the case just cited the dealer intends to sell tubes, and many of them. The information card is just a matter of storing up nuts for the winter.

There are other dealers who are opposed to the use of direct mail (probably because they won't read advertising letters and are therefore sure nobody reads them), but who make a house-to-house sales campaign very profitable. In some cases they have their men take along a tester as in the above outlined method. test the tubes right before the customer's eyes, and offer to replace the weak ones. Others give the customer the "ear test," replacing each tube with a good one for the purpose of comparison. If the new one shows a noticeable improvement in the volume or quality of the receiver the salesman usually digs down for change.

The Eveready Raytheon Company has recently been conducting a campaign offering a free demonstration to those who use the coupons in the corner of the ads. They are striving to get across the idea of a complete new set of tubes, as is the R. C. A. Radiotron Company, who advise that the customer "Replace all the vacuum tubes in your radio set with R. C. A. Radiotrons at least once a year." While such a policy seems rather absurd to some, especially those who have used tubes for two or three years and still find them in excellent shape, it is no more far-fetched than the idea that the tire companies have successfully put across—that a new tire should never be used with an old inner tube.

One dealer expressed the opinion that the Eveready ad, in offering free demonstrations, was going to get the dealer

in dutch; that he would have to average four trips per sale, that he would have tubes spread around all over the city on demonstration, that in nine cases out of ten the customer couldn't afford to buy a complete new set of tubes even if it did improve reception, and that he knew of one dealer who had put back the old tubes in the wrong sockets and the customer complained that the set was not operating as efficiently as before he came to show his wares.

All these may be, but it seems that one trip would be enough (providing there was someone home), that a home demonstration of tubes, unlike a home demonstration of a radio set, would not necessitate leaving the tubes on the premises for the customer to push in and pull out, and that any salesman who couldn't put the old tubes back in the order in which he found them should look for a job pulling corks in a drug store.

Regarding the ability to purchase a complete set of tubes, or the necessity of purchasing so many, it might be said that it is neither a crime nor an insult to try to sell the whole store in one fell swoop. The whole batch may not be necessary; neither is a third pair of shoes. If, after the salesman has said his say, the customer is going to feel surer of his reception for the next year by purchasing the complete set, why shouldn't he be allowed to have that satisfaction? That is salesmanship; the kind that is required to keep the radio dealer alive in these days of merchandising strife. If Eveready and Radiotron and the other outfits can put across the same idea that the tire companies have put over, the dealer who will not cash-in is short-sighted.

Another method of selling tubes in the home is that practiced by the service man. Nowadays most dealers pay their service men a commission on the merchandise they sell while on the job. This is not only a fair thing to do, but a good sound method of making the service man keep alive to his opportunities. All tubes should be tested on every service call, even if the trouble was in the speaker or the wall socket. If one tube is weak the owner should be informed of it and allowed to listen to the receiver with a good tube in its place. One splendid plan that is religiously followed by many dealers and service men is that of sticking a gummed label on all tubes each time they are tested, writing a notation on the label as to the tube's actual condition. If the customer does not want to replace a tube that is not quite up to average at the time, she will always be somewhat worried about it until she does have it changed.

Tube testing, at the store or in the home, by salesman, solicitor or service man, is a delicate job. The scale on a

meter, a chart to go with it, or a graph, mean absolutely nothing to the radio customer. If he or she is inclined to be at all suspicious, a tube test where figures are used offers a fine opportunity for suspecting. There are tube testers on the market now that are fitted with dials that read merely, "Good—Fair—Poor." To build one is the simplest thing in the world for a good service man, and the use of such an instrument would certainly make life easier for the demonstrator.

In summing up, may it be remembered that the dealer who wants to make his tube business an independent source of profit should study the manufacturer's advertising to the consumer and to the trade. He must carry on the same message in his own copy. He must use the dealer helps and trim his windows and his shelves consistently and with taste. He should not wait for the person who enters his store to bring up the subject of tubes, but should take every opportunity to advise the purchase of a new batch or offer to send a man out to test them. He should never allow a person to leave the store without a log book or a pencil or some sort of an advertising novelty bearing the name of the tube he is pushing. He should make good use of direct mail and house-to-house sales possibilities. He must use the service men to the fullest of their sales possibilities. He must be equipped to test a tube to the satisfaction of the customer. And he must pound away like a pile driver.

The Trend of Radio Merchandising

By H. C. GRUBBS
Vice-President, RCA-Victor Company

1. Careful correlation of experimental and production methods with market conditions.
2. More solid place for radio among the sound staple articles of merchandise.
3. Tightening all along the line of retail merchandising, insuring a fair profit for the dealer.
4. Increased demand for modern receiving sets because of (a) improved economic conditions; (b) better values in modern equipment.
5. Preference for combination record playing and radio instruments.
6. Concentration on few lines, expediting turnover and reducing stock investment.
7. Larger percentage of store sales; more intelligent outside selling effort to supplement store activities.
8. Intensified sales promotion activities of leading manufacturers.
9. More scientific methods of store management and retail selling.
10. More genuine service from the manufacturer to the dealer; from the dealer to the public.

What Radio Salesmen Should Know About Broadcasting

By HECKERT L. PARKER

JUST how much a retail salesman should know about broadcasting programs and broadcasting in general is a subject upon which retailers have differed. One type of dealer will cite the thousands of receiving sets which have been sold where the salesman scarcely mentioned the subject of radio artists or programs while making sales. To the broadcast station program-personnel this is incomprehensible. Stations are mentioned during every sales talk, but by the class of salesmen referred to, such reference has been largely with respect to the ability of the receiver in question to tune in certain stations sharply, or receive certain stations clearly or with satisfactory volume.

Radio users are perhaps better acquainted with different programs than the average dealer; certainly at this time they know programs better than they know the relative merits of different types of receiving sets. As radio users' knowledge of detailed differences in types of receivers becomes greater, they will begin to tie the two together, thereby forcing the salesmen to know programs thoroughly. The value of a receiving set rests entirely upon what it gets from broadcast stations. After all, the primary buying-motive which actuates the purchase of a receiver is the prospect's expectation of programs that will please him. If the listener doesn't get what he likes from his radio set, he will cease to listen and there will be no sales of radio sets.

The finest picture theatre would have a slim chance to fill up two or three thousand seats by hanging out a sign which merely says: "Talking picture today; very good; seats 65 cents! lasts two hours." Certainly the names of the principal performers, or other features of the picture or stage performance, would have to be extensively advertised to insure a paying audience.

In years past many lyceum bureaus conducted series of lectures or entertainment programs. In each city or village the whole series of ten to twenty programs scheduled over winter months, and costing from \$10 to \$100, would be sold on a "season ticket" to thousands of people. Many tickets were bought because of the fame of some of the coming attractions, but many others bought without examining in detail the nature of the performances to be given

during the year. People bought these season tickets in advance, and on faith, because they had heard their friends and neighbors discuss particular features of the past seasons' series and express pleasure with them.

Has radio progressed, now, to a point where the public takes for granted that the season's radio broadcast programs will justify their buying a season ticket in advance by buying a radio receiver? If that is true, then, when the purchase of a new receiver is being undertaken, the matter of individual artists or programs, or the continuance of particular stations, seems not to be as important to the prospective purchaser as the probability of permanence of broadcasting, or satisfaction with programs as they now are given, or faith in the general improvement of all broadcast programs as time goes on. If there is to be no broadcasting at all, or, to some people, if programs are not to improve, why buy a radio set at all? These questions do arise; the ability to answer them insures that the student radio-salesman knows the essential points about the whole broadcasting structure.

Seats in auditoriums vary in price. High-priced box seats offer privacy and comfort. Soft seats, with plenty of room to stretch, located half-way back from screen or stage, are worth more to some people than front-row locations are worth to people hard of hearing or with poor eyesight. Radio programs can be heard with any receiver, but to get radio program enjoyment with comfort, equal to that possible at the theatre from the best located box seats, means that receivers, to provide that enjoyment, cost more than just any receiver. If this point is to be made clear to prospective receiver purchasers, then some knowledge of daily radio broadcast programs and artists is required on the part of the radio salesman.

About 15% to 25% of the broadcasting time is taken up with chain programs which are of national interest. The large chain programs are becoming more and more national in scope, and before a year has elapsed international events will be offered frequently. These require enough reading of current events for the salesman to be at least able to carry on some intelligent conversation about such programs. A large hook-up

of about 45 stations sponsored by an advertiser, for one-half period costs from \$6,000 to \$7,000 for station time only, exclusive of the cost of artists or other talent which costs anywhere from \$250 to \$2500, or more, additional, for one program. Only the largest institutions can afford to pay such prices for institutional or goodwill advertising, and the program itself must be worth while to insure that a large audience will listen to it. However, these programs get satisfactory results, as evidenced by the fact that many national radio advertisers have renewed their contracts several times, some having been on the air almost continuously for over three years.

When stations affiliated with the chains are not handling chain programs—also on stations not affiliated with chains—local programs, by artists known only locally, must be used. This requires study of purely local broadcast offerings and such information is generally accessible to the ambitious salesman. Local or "spot" advertising will always be valuable and necessary for many commodities where local distribution presents a purely local advertising problem. Local events require broadcasting facilities, and in these broadcasts local people will be just as much interested as they are at other times interested in national and international topics.

When there is an abundance of news, or advertising, the newspaper or magazine can add another page or two, but the time available for a broadcast station is fixed by the clock. Not another minute can be added to the day. Therefore, as programs become better, station time will become more valuable.

Partially informed people may question the performance of radio broadcasting because of the somewhat insecure foundation upon which broadcast stations have invested millions of dollars. As much as \$100,000 may be tied up in studios and transmitter equipment by a 500 or 1000-watt station which is absolutely dependent upon the mercy of the Federal Radio Commission to continue in operation. Licenses are granted by the Radio Commission for three-month periods only and must be renewed at the end of each three-month period. If a renewal is not granted, what can the station owners hope to salvage of the capital invested?

For private individuals to invest large amounts of capital on such slim foundations might seem at first to be a risky undertaking, but more careful consideration discloses that, in the end, the Federal Radio Commission is responsible to the people as a whole. When the great mass of people of this country wants anything as much as it wants radio, the government will see that it gets it.

Radio broadcasting which was the outgrowth of years of development of "wireless" code transmissions, really started in 1921 when the Westinghouse Company applied to the Secretary of Commerce for a license for station KDKA to broadcast music and voice. This was a new class of service for which the radio law of 1912 made no specific provision; however, under that law a place had to be provided for it. The Secretary of Commerce finally determined on a wavelength of 360 meters (to KDKA) because that was far enough away from the frequencies used by ships, in the light of development at that time, so that interference was not likely to result. Therein the license to KDKA brought the first popular broadcast station into existence. The first broadcast of voice and music from this station, that was given any newspaper publicity, was of the election returns in November, 1920. It is estimated that not over 50 people heard it. The election returns in November of this year (1930) were heard via radio by over fifty million people in this country.

As other broadcast stations were erected they were all assigned to that 360-meter wavelength. The interference problem started, then, has been a bone of contention ever since.

In 1923 Herbert Hoover, then Secretary of Commerce, called a conference of all interests in an attempt to bring order out of the confusion. At this conference a definite broadcast band was established by dividing up the entire radio frequency spectrum and allocating the frequencies among the different services.

Secretary Hoover proceeded to assign wavelengths to broadcast stations in the frequency band decided upon for that service at this conference. There were not many stations, and none with very high power—500 watts being most generally used. Soon more and more stations applied for license, and more and more power was used, until about 500 stations were operating.

In 1926 a Federal District Court decision was rendered in a case brought by a station in Chicago, to the effect that no authority rests with the Secretary of Commerce to make individual wavelength assignments to broadcast stations; and that stations were free to

operate on any wavelength or with any power they choose; and, otherwise, the Department of Commerce had no legal control over them. This broke down all restraint. In July, 1926, when this decision was rendered, there were 526 broadcast licenses, with no room for any more. By March, 1927, there were 734 stations; and the total power for all stations had increased from 378,000 watts to 647,000 watts. Even the broadcasters themselves were dissatisfied, because they could not get their programs out in a satisfactory manner. The listening public was even more dissatisfied, and there being some 20,000,000 listeners by that time, their protests were heard and acted upon by their representatives in the Congress and Senate. Inasmuch as radio is naturally an interstate business, individual states are without constitutional authority to pass regulatory laws; regulation must be by the Federal Government.

The federal law, which resulted from the existing confusion and general dissatisfaction, was enacted and signed by President Coolidge in February, 1927. By its provisions, every radio license of any kind was terminated 60 days after passage of this law. It affected all telegraph companies, amateurs and ships,

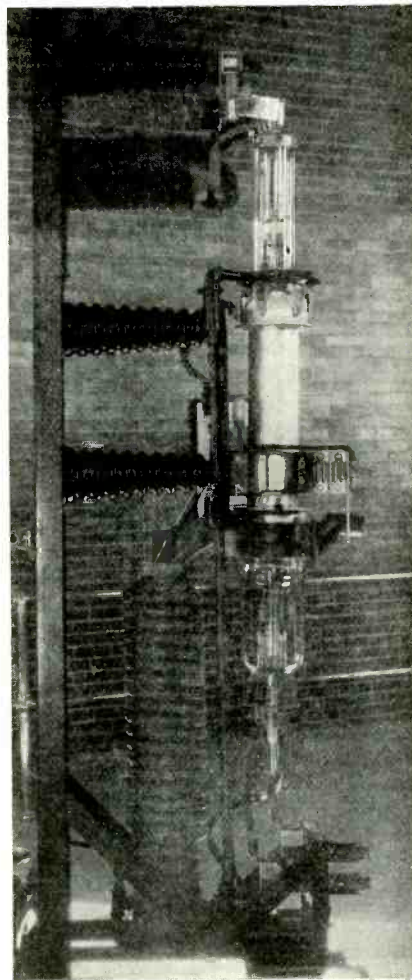

100 KW Water-Cooled Tube Used in New KDKA Transmitter

as well as broadcast stations. It wiped the slate clean and provided means for the proper governmental authority to issue licenses to applicants who could and would comply with the provisions of the new law. The law stipulates that its provisions shall be put into effect by a board known as the Federal Radio Commission.

This body is comprised of five members, appointed by the President and confirmed by the Senate. The law expressly provides that no one shall be allowed to operate a radio transmitting apparatus (telegraph, telephone, television, etc.) without first proving that his engaging in that business is in accord with "public interest, convenience and necessity." Mere desire to start a broadcasting station will not suffice to secure a license, unless that the applicant can prove that the public desires such a station. The receiver of broadcast programs—that is, the mass of listeners themselves—is therefore the dominant element in broadcasting, and whatever is done about broadcasting must be done for their convenience and necessity. That is why, every three months, before every broadcaster's license is renewed, the stations must prove to the Radio Commission that the public still desires that station to continue broadcasting.

Later, Congress passed on to the Commission further instructions as to the granting of broadcast licenses that are the cause of considerable discussion by broadcasters, and by the listening public. These provisions divide the country into five zones, and require that the Commission grant broadcast licenses in each zone, equally, as to the number of stations, power used, and time on the air; and it must make a similar allocation of licenses in proportion to the population of each State.

So far, no provision has been established for the Radio Commission, or any one except the stations themselves, to act as censor over what is broadcast by stations. The nearest approach to anything of that kind is the rule that phonograph records shall be announced as such, which means that a station shall not infer that performers are before the microphone in person. Stations are required to announce their call letters every fifteen minutes, merely to assist governmental technical investigation in checking power and frequency of stations on the air. Anyone speaking through the microphone is subject to state and municipal laws governing libel and slander; and recently the Federal Radio Commission refused renewal of a license to a station in Oregon because obscene language had been broadcast.

Under the United States Copyright Laws, no one shall use copyrighted mu-

sic for the purpose of public performance, for profit, without consent of the author. The Society of Authors and Composers exercises its right under this law and offers to license broadcast stations, for a stipulated yearly fee, to use music copyrighted by any of its members. The amount of this fee varies, according to the population of the city in which the station is located, and with the power and popularity of the station. Some 100-watt stations may pay \$100 yearly; others of the same power pay \$1,000 yearly. A 1000-watt station may pay as high as \$5,000 per year. To add to the complication, the Society, at times, prohibits the use of certain pieces or numbers. When a particular prohibited number is required for some specific program, the station desiring it must make a written request to the Society for that one particular time they may desire to broadcast that number. If the reason given seems sufficient, the Society will grant the request. This sometimes takes a few days to accomplish, and is but one of the many reasons why stations are forced to settle all details of every program several days in advance of its broadcast. In many cities the Musicians Union imposes harsh rules, or demands excessive pay for broadcasting by any of its members.

An impression exists that there must be a lot of profit in broadcasting. But, in view of the difficulties and restrictions under which broadcast stations operate, one may well ask why anyone wants to engage in that business. In some individual cases, stations have been more or less profitable; but the largest and best early stations were started by radio receiving set and tube manufacturers to insure that the public who purchased their devices had suitable programs; and, for several years, these stations were operated, and some still operate at considerable loss to the station owners. There are special institutions such as colleges, churches, etc., operating stations without profit; and for years several stations have been operated by newspapers, either by direct ownership or by affiliation where the newspaper paid part or all of the deficit to keep the station on the air.

The Radio Commission now requires stations to submit reports of expenses and earnings which will show whether or not the station is making money. If a station does not make money enough to support itself by the sale of time for commercial sponsored programs, then the motive which keeps the owners pouring in money year after year to give free or sustaining programs might have an important bearing on whether or not the station is being operated in accord with the public interest, convenience and necessity.

Reports for the first half of 1930 show that the average time sold by all stations is about 35% to 40% of the total time on the air; and that about 50% of the stations operating at this time show a profit, while the others still lose money from their operations.

Radio users frequently kick about the use of any advertising over broadcast stations, and, unfortunately, there are dealers short-sighted enough to kick about the same thing. No one is obligated to provide any radio programs at any time in the United States. In England, and in several other foreign countries, each owner of a receiving set must pay a governmental tax of two or three dollars per year for the privilege of owning a receiver. The government controls all broadcasting and does not permit any advertising. From statements of many individuals who have listened to programs in Europe and here, the general character and wide diversity of programs available to American (and Canadian) listeners is much superior to the programs available, generally, in England or any other part of Europe.

Short sales talks are objectional to but very few listeners. Objections are well taken, though, against the blatant radio advertiser who monopolizes most of his period by a cold, uninteresting recital of the merits of his service or merchandise.

Surveys show that over 50% of receiving set owners do buy merchandise advertised over radio. And a still greater number state they give preference to radio advertisers when buying commodities or services that are highly competitive.

If radio advertisers continue to derive still greater results from the programs they pay for, then they can afford to use less time for sales messages and more time for the entertainment part of their programs, employ still better talent and pay still higher rates to the broadcast stations to insure that good stations will continue to stay in business. Ultimately these conditions will be fulfilled; then the radio listener will be provided with an abundance of good programs.

Radio apparatus manufacturers still pay a large part of the cost of programs. In 1929 radio manufacturers spent \$20,000,000 in newspapers, \$8,000,000 on radio programs, and \$12,000,000 on outdoor advertising, dealer material, trade papers, etc. This year (1930) the cost of radio programs provided to listeners will amount to over \$50,000,000. This vast sum will be paid for artists, station personnel, administration executives, incidental expenses and rentals for wire connections between stations on the chains. Radio apparatus manufacturers will pay about 20% of this cost, advertisers or spon-

sors, and the stations themselves paying the remainder. The retail salesman in selling receivers is simply selling the listener a seat to hear this big show.

It isn't all a "show" because radio programs are almost as diversified as are the interests in the daily lives of listeners. Broadcasters strive to provide programs that will please the greatest number of people. Manifestly it is impossible for any program to please all people, or for programs on any one station to please all listeners all of the time. For example, surveys made by stations, and others, to determine what listeners do like, show that from 15% to 25% of listeners are interested in or express appreciation of religious programs. Similar figures show the interest in sports, in classes of music preferred, etc. About one-third of the listening public is directly connected with agriculture, forestry, or animal husbandry, so that special programs of interest to the farmer and rancher are an important factor in their lives but not necessarily important to other classes. No one can predict how radio will be used for educational purposes or estimate its great value for that purpose.

Will this keep up? Will programs continue to improve? Will there be an incentive for people to continue, year after year, to buy more receivers, and still more people discard old receivers for new improved types?

The answer lies in the action of advertisers who have had successful returns on the cost of radio advertising as compared with costs of advertising in other media. The more popular stations have raised their rates each year and continue to retain as sponsors, business organizations who have advertised on a station consistently for two or three years.

Radio apparatus manufacturers can not be expected to continue to pay the whole bill for programs; therefore, if advertising by other kinds of business interests must be depended upon to insure the permanence of enough good, varied broadcasting, it is important to consider how radio advertising compares with other media. Newspapers seem the most likely direct competitor of broadcasting now, but they really supplement each other. As evidence of how the owners of newspapers consider broadcasting, it is interesting to note that newspapers now have more actual money invested in the ownership and operation of broadcast stations than any other class of business, industry, or institutions. Three-fourths of the revenue in the newspaper publishing business comes from advertisers, and one-fourth from subscriptions or street sales. Two-thirds of the revenue of magazines comes from their advertisers, and one-third from

(Continued on Page 34)

Selling Radio *by Recorded Music*



THE Victor Record-of-the-Month for November, in the field of great music, is the famous baritone aria, *Largo al Factotum*, from Rossini's "The Barber of Seville," Victor record No. 7353. Lawrence Tibbett is the gay and lively barber, and his voice is rich and full and capable of tremendous range. The artist's splendid control of his voice, especially at the close of the aria where his words come forth like machine gun bullets, makes the hearer marvel. Quite in contrast to *Largo al Factotum* is the aria *Eri tu*, from "The Masked Ball," by Verdi. This is a beautiful melody, in slow tempo, sung in exquisite legato. This side of the record is perhaps even better for the purposes of demonstrating the tone of an instrument than "The Barber of Seville" aria because it is slow enough and the tones are held long enough for the listener to recognize the true fullness of the voice, which would be absent if any other than Lawrence Tibbett were singing, or if it were being reproduced on an inferior machine. The contrast between the two selections show the artist's unusual versatility.

SIGRID ONEGIN has a most unusual soprano voice, full and expressive, almost, of the violin. In Victor record No. 7320 Mme. Onegin sings the two most popular arias from Saint-Saens' opera, "Samson et Delila," the alluring melody of "My Heart at Thy Sweet Voice," and the fascinating "Printemps Qui Commence." While these are opera selections of the highest order, they are not "over the heads" of people who are not trained in the appreciation of the finer music. Both are familiar melodies heard frequently over the radio and admired and loved by everyone.

ONE of the Columbia Masterworks Sets, Columbia records Nos. 67708, 9 and 10-D, is one of the finest and most unusual of orchestral collections in existence. It contains, in the six parts, the great *Iberia* suite of Albeniz, arranged for the orchestra by Enrique Fernandez Arbos, who also conducts the Madrid Symphony Orchestra in the recording of this suite. It is Spanish music, written by a Spaniard, orchestrated by another Spaniard and played by a Spanish orchestra; not an

orchestra of the guitar and castanet type, but an excellent symphony.

The first of the six parts, *Evocacion*, is in slow waltz time, typical of the graceful Andalusian dance. The second, *El Puerto*, is also Andalusian in theme, being based upon the original Spanish tango, a form quite distinct from the Argentinian tango. The radio salesman will be interested in knowing that in this part, as well as scattered throughout the other parts, the extreme high and low notes are most splendidly brought out; isolated so that the untrained listener can identify them and know for himself that the radio receiver-phonograph combination is capable of reproducing them—if it is.

El Corpus en Sevilla (*Corpus Christi Festival in Seville*) is in two parts, the third and fourth; is exuberant and joyous in theme, presenting a musical spectacle of a procession in the ancient city of Seville at the great festival of *Corpus Christi*. Commencing with a march movement announced by rataplans on the drums, the main theme emerges with the full orchestra, the rataplans continuing in the background. A folk tune is introduced, finally dying away in the distance while the throbbing echo of the drums concludes the fourth part.

The third record, containing parts five and six, give a tonal impression of *Triana*, a suburb of old Seville. There are two main themes in this piece, heard alternately. One is based upon an Andalusian dance, while in the second is heard the melodious tinkle of the Andalusian bells. In the finale the rumbling of the basso almost vibrates the heaviest cabinet. It is bass music to the depths. And with it the bells offer notes so high

that a slight turn of the tone control cuts them out of the picture entirely. The blare of the trumpets adds brilliance that will stay with the listener the rest of the day.

JESSE CRAWFORD is out with a new organ number, Victor 22551, which is as effectual in selling the idea of the phonograph combination as are Crawford's other records. *Little White Lies* and *Confessin'* are the two numbers played by this unrivalled artist, and both are typical of his theatrical style, full of chromatic runs and the tinkle of bells. Neither the bass notes nor the extremely high tones are brought out with unusual isolation but this organist has many devotees, and to those this record will sell more radio sets than one which would explain the certain points in the salesman's speech. Crawford winds up each of the pieces, as usual, with lots of snap, just as the theater organist when the curtain begins to lift for the next act and the spotlight goes out.

ANOTHER of the Brunswick ninety thousand series, *Symphony in G Minor* No. 40, appears on Brunswick Record Number 90082. This is played by the State Opera Orchestra in Berlin, Richard Strauss conducting. This series of records, as indicated by the serial numbers, is recorded in Europe, and mighty splendidly recorded, too. Every instrument stands out as if a microphone had been placed on each music rack. Both the lows and highs are very prominent in this record, making it doubly applicable for a demonstrating record.

MISCHA ELMAN has been known as a great violinist for a couple of decades or more. His fullness of tone has been the inspiration of violinists the world over, the "Elman tone" being almost a comparative standard ever sought by all. In Victor Record No. 1482 Elman plays the well-known "Träumerei" by Schumann and the "Valse Sentimentale" by Franz Schubert, with the same depth of feeling that has made all his other records so popular among lovers of violin music. Both are accompanied by the piano.



PROFIT PROMOTION through Proper Store Management

By WILLIAM E. KOCH

Associate Professor of Merchandising,
University of Southern California

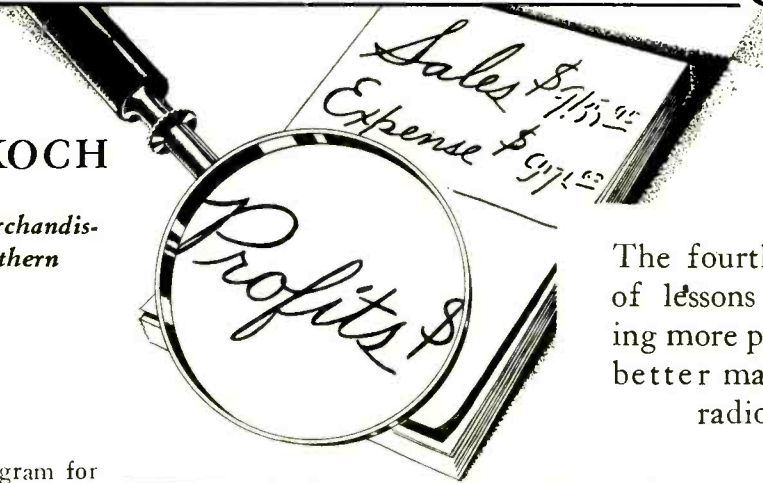

The fourth of a series of lessons about making more profit through better management of radio stores.

"I want a profit-making program for my store. I know that such a program means more to the continued success of my business than any other one thing. But I don't know just where to begin or how to go about it."

A number of wide-awake merchants have expressed themselves in much this same way. It is safe to assume therefore, that many readers of RADIO are interested in both the where-to-begin and the how-to-go-about-it as applied to a carefully constructed profit-making program.

As we study these questions, one fact impresses us immediately: The most important part of the job lies in developing a clear conception of just what the profit-producing process involves in a fundamental way. We have that conception when we see how and why planning and acting and controlling are the basic essentials; and how and why sales quotas and stock limits and mark-ups and expense budgets stand as basic elements in the profit-making program.

After we have pictured the fundamental profit-making plan in figures, as illustrated in our lesson for last month, we have covered the "where to begin" and are well on the way in "how to go about it." From that time on, it is largely a matter of refinement and adjustment; first making sure that our planned fundamental figures are as nearly right as they can be made, then following with suitable divisions and subdivisions.

We find it decidedly helpful, therefore, to turn our attention more specifically to the first of the four basic elements in the fundamental profit-making plan—the sales quota.

Why Set a Sales Quota?

QUITE aside from the fact that no profit-making plan can be developed without setting a sales quota, let us devote a bit of our thinking to some

What the Radio Retailer Can Do With Sales Quotas

The sales quota is but a part of the profit-making program. Successful quota setting is based on a clear conception of the profit-producing process. Consistent sales quotas lead to greater profit volume. Selling possibilities must be measured in relation to their profit-producing possibilities. Information and imagination are needed because they determine judgment.

of the reasons why quota setting is necessary in producing the maximum volume of profit.

Not all radio dealers are as completely "sold" on the quota idea as they might be, you know. Some still look upon it as a fad which will run its course, like a fever, and be done with. Some, even, have "tried it and found it wanting."

Consider, for example, the case of a retailer who asked "Why set a quota?" in a tone of voice which clearly indicated that he could see nothing to it but useless waste of energy and hindrance to progress. And this from a merchant who can point with considerable pride to the success of his business in the past.

He is a typical member of the "old school" of retailers who operate without thinking very much about the harmonious relationship of their planning and acting and controlling; and without realizing how helpful it is to work with a well-developed fundamental plan for profit-producing that is based on the sales quota, the stock limit, the mark-up or discount, and the expense budget.

Many a merchant of this type, through exceptional inborn ability or unusually favorable condition, or both, has scored a gratifying profit without very much assistance from modern

methods of management. In times of easy sledding we do not ordinarily feel the need for such a profit-making device as the sales quota, and therefore are not much interested in studying it. But the trend of business conditions forces us to realize that modern methods become increasingly necessary.

The real reason for setting sales quotas is, of course, to assist in increasing the profit volume. When that commendable objective is not reached, we may be sure that something needs mending. What you, as a radio dealer, can do with sales quotas is all summed up in four words—*increase your profit volume.*

How Sales Quotas Help

EVERY quota sets a definite goal of accomplishment, and that in itself is a great help. In fact, all other helps lead right up to this one because each pertains, in one way or another, to making our goal as nearly right as possible—as nearly productive of maximum long-run profit as possible.

Quota setting induces careful consideration of various possibilities for increasing sales. It serves as a thought stimulator. It helps us to recognize sales possibilities that might otherwise be overlooked. It leads to that "additional volume" which is one of the greatest known profit producers.

Some radio dealer may say: "Oh, but I don't overlook any selling bets. I get all the business it is possible to bag. My only trouble is that there isn't enough business to be bagged. No thinking about sales quotas will find any way to increase my sales," and then we might ask: "How do you know?"

Indeed, quota setting is decidedly helpful in that it guards against an overdose of the-trouble-is-not-with-me attitude. It helps to keep the mind open and "in tune" for constructive thinking

and effective observation along the lines of consistent sales possibilities and how to reach them.

But the helpful influence of setting sales quotas deliberately and thoughtfully reaches much farther. Especially so, when we consider our sales quotas in connection with the other profit-making factors. We then study our entire business structure more analytically, thus bringing to light hidden possibilities for increasing our sales and profit volume.

Such consideration also helps us to see our sales-producing possibilities more clearly in relation to their profit-producing possibilities, which is an outstanding need in business right now.

Space limit prevents a discussion of other benefits, such as the stimulation of interest among the entire organization; but every radio dealer will reap these benefits in proportion as he develops his understanding and use of the quota principle.

A Guess Will Set a Quota

THE right kind of a start in quota-setting is practically sure to lead to constant betterment. As in every other phase of planning for profit, the cumulative benefits keep growing because no thoughtful planner ever feels that he has reached the limit of his possibilities.

The never-to-be-quite-reached limit in quota improvements is indicated by the fact that a guess will make a start. From the rough beginning of a purely guessed-at quota, possible improvement extends as far as individual vision and judgment will permit.

The simplest sales quota that can be set is an amount literally guessed at and taken as a sales goal for a given time period. Some dealers even set sales quotas without realizing that they are doing so, and sometimes without thinking very much about it. Anyone who

says, "I'll try (or let's try) to sell . . . (whatever the amount may be) next . . . (whatever the time period may be)," has set a quota.

In fact, any mental picture of expected accomplishment is a simple form of quota. The next step is to get it down in black and white; both to remind ourselves of the goal we have set, and to stimulate our observation and analytic thinking toward making the goal a better one. Quite remarkable, you know, how it helps to see the thing in black and white.

When we look at the first rough figure and ask ourselves, "Why have I set my quota at this amount?"—well, then we are on the way. The answer to that question leads to every possible improvement in the setting of sales quota. A guess will set a quota, but by no means the best possible quota.

Information and Imagination Are Needed

THE best possible quota differs from the guessed-at start only to the extent that it more nearly hits the point of "just-rightness" through the exercise of judgment. But that possible difference is truly a tremendous one.

Good quota-setting is merely a matter of good planning ahead. Good planning ahead is merely a matter of good judgment, properly applied. Good judgment always requires a wholesome combination of information and imagination.

Quotas set by "rule" are practically in the same class as those set by straight guess. The store, for example, which aims to make each succeeding year produce sales a certain per cent above the preceding year, or above the average for several preceding years, is obviously applying a "rule."

Of course the sales records must play an important part in the setting of quotas, but not the only part. The

conditions that influence accomplishment must be considered thoughtfully to arrive at a consistent sales goal. Conditions may be such, you know, that it actually becomes better business to strive for less business in one period than another. It invariably is a question of possible accomplishment at maximum profit.

Some of the important factors to be considered in connection with the sales records are:

1. The general customer-attracting power and individuality of the store.
2. The efficiency of the store's personnel in both buying and selling.
3. The condition of the market.
4. The effectiveness of existing and probable competition.
5. The influence of the trend in fashions.
6. The buying mood and buying power of the store's trade territory.

Information of this kind is obtained through keeping records, through studying the facts the records reveal, and through general observation. Then imagination or vision must be mixed with the information to arrive at the most profitable sales goal for the store.

Divisions and Subdivisions Follow

THUS far, we have considered primarily the sales quota for the store as a whole. The next step takes us into the possibilities for divisions and subdivisions which have much to do with making the quota principle bring maximum benefits.

In fact, the more we study our profit-making program—how to build it and how to use it—the clearer we see that suitable divisions and subdivisions are the real pith of modern management and control. This study also helps us to see more clearly why the most advantageous divisions for any store rests with the manager's individual judgment.

Each manager must judge for himself because the benefits are not primarily in proportion to the divisions, but in proportion to the practical use that is made of them. This all-important matter of use invariably checks back to the manager himself.

One radio dealer may find that he can obtain his greatest guidance and control with but a few departmental divisions such as new sets, used sets, tubes, accessories, and service. Another will recognize a distinct advantage in more departmental divisions, and in subdivisions for some or all of them.

The sales goal for the store must be reached through two separate avenues: (1) Through the sales made in each of the various classes of merchandise and service; (2) Through the sales made by each member of the sales force.

So we separate our sales quota for the store as a whole to determine how much each merchandise division is to con-

(Continued on Page 34)

Sales Quota for period of _____ months ending _____ 19____					
MERCHANDISE DIVISION	Record of Previous Period			Estimate for Next Period	
	Sales Quota	Actual Sales	REMARKS	Sales Quota	REMARKS

A simple form that will help the radio dealer in setting his sales quotas. The first line is for a main division, such as the store as a whole or a department. The following lines are for any desired subdivisions of the main division—departments, lines, items, salesmen. A separate sheet is used for each time period. Nothing more than a pencil sketch of the form is required.

Radiotorial Comment

By the Editor

EVERYBODY knows that there is something the matter with the radio business and that until this something is corrected no big money will be made. Many radio dealers have their own opinions as to the

What's the Matter with This Radio Business

practically the same as those expressed by six hundred dealers in ninety-two cities and towns throughout thirty-four states, as personally interviewed during a survey conducted by *McCall's Magazine*, which has recently published its findings in a book called *This Radio Business*. It may be of interest to briefly review these findings and to consider a few additional facts.

The gist of the dealers' opinions is that the manufacturer is at fault in sanctioning and encouraging certain unsound sales practices. He has forced inflexible sales quotas upon the wholesalers. He has too frequently and too suddenly made changes in models. He has saddled the "free home demonstration without obligation" upon the dealer. He has encouraged excessive trade-in allowances. These indictments do not apply to every manufacturer, of course, but they do apply to enough, in the opinion of the dealers, to be responsible for many of the difficulties with which the dealer has to contend.

Inflexible sales quotas, whereby a wholesaler is obliged to handle an arbitrarily fixed number of sets each season, have sometimes caused him to take on undesirable retail outlets, which compete with legitimate dealers. Wholesale prices are given to individuals who sell at cut prices. Standard discounts are slashed. Is it any wonder that the unfavored legitimated dealer finds it hard to make ends meet?

Whenever any change is made in models the dealer should be confidentially notified far enough in advance so that he can clear his stock. Otherwise he is left holding the bag when the manufacturer suddenly brings out a new model with "revolutionary improvements."

The free demonstration evil has been discussed so often as to require no further comment here. When home demonstrations are necessary to close a sale, the dealer should charge a fee which may be applied on the purchase price. But few legitimate prospects are lost by this practice, and the joy-rider is effectually eliminated.

causes and have not hesitated in advising the editor of RADIO about them. Nor is it strange that these opinions should be

Excessive trade-in allowances are bad enough when made by dealers. But when advertised by the manufacturer the public soon concludes that the advertised set is over-priced. The trade-in privilege seems to be necessary in order to replace old sets with new, but the manufacturer and dealer should work together in developing a plan that will bring about a reasonable and definite relationship between allowance and disposal value.

It must be recognized that the foregoing presents only one side of the picture. While the manufacturer may admit that forty per cent of the failures are due to these causes, he contends that sixty per cent of them are due to the retailer's lack of knowledge of his business. In installment selling, for instance, an excessive number of re-possession can be avoided only by careful investigation of a purchaser's credit standing and by a substantial initial payment.

Today the radio dealer is a merchandiser rather than a technician. While midget sets and cut-price articles may sell themselves, standard models require real sales ability in order to move them. One of the dealer's greatest problems is to erase the low price mark from the buyer's mind.

In order to sell the higher priced models which carry enough cash margin to justify the necessary sales effort, particular stress must be laid upon the better tone range which is obtainable from the larger baffle surface. Then again the dealer should cooperate with the manufacturer in creating new customers by constantly reminding them of the enjoyment and benefits that accrue from listening to the radio programs.

But here again there is something wrong with radio. Thousands of persons who have heard radio don't want one in their homes and thousands of sets are silent from one week to another. Why?

Each person has his own reason, but the consensus of opinion seems to be that there is too much talking by announcers. While people are listening to music they object to interruptions by the insistent, dominating tones which most announcers use. Fifty words seem to be the acceptable limit, even when delivered in an easy, conversational style. If the announcer talks any longer there is a general tendency to turn off the set or tune in another station. Thus a station not only loses its audience but a dealer also loses sales. This one fault in radio has killed more radio sales prospects than any mediocrity of programs. It is a subject that dealers, individually and collectively, should bring to the attention of broadcasters.

These various suggestions have been made in a sincere desire to help the radio dealer. They are not based upon any shallow pretense that "happy days are here again" or that mere whoopee will cure the situation. It must be faced before it can be cured.

CALL off all bets that radio moving pictures are not practical. The seemingly impossible has been accomplished. For over a month a brilliant young San Franciscan, Philo T. Farnsworth, has been electrically transmitting acceptable moving pictures which require a narrower waveband than now employed by broadcasters of speech and music. The word "acceptable" is ultra-conservative. The received images are brilliantly black and white, with the same half-tone gradations as are found in good newspaper illustrations. This detail covers an area four inches square, and has no more flicker than that given by the usual home movie projector. Such sort of entertainment will satisfy any home.

Granting that this development is still only in the laboratory stage, conceding that months of work must be done before it will be ready for sale to the layman, admitting that the transmission is over only a few feet of wire, yet the fact remains that any present broadcaster, at relatively small expense, could install a transmitter to send out impulses on its present wavelength and that these could be reproduced in any home on a receiver whose present cost need not exceed two hundred dollars. Imagine what a boon this will be to the radio business.

A complete description of the method whereby these results are obtained can be understood only by a trained engineer. Suffice it to say here that the variation in light intensity from the pictures causes the emission of correspondingly variable numbers of electrons from a light sensitive material in a large vacuum tube. These electrons are electrostatically moved and magnetically focused into a beam which rapidly sweeps back and forth across a target in one end of the tube. Thus the picture is scanned and converted into various electrical frequencies which correspond to the original variations in light intensity.

The current from this dissector tube contains components of frequencies as high as a million cycles. This current is passed through a lowpass filter which suppresses all frequencies excepting those in a 6-kilocycle band. These are amplified, and either transmitted by land line or modulated upon a carrier wave in the same manner as is a voice current.

At the receiver, "believe it or not," the low frequency waves re-establish the high frequency components previously filtered out, and the picture is rebuilt by means of a cathode ray tube containing a fluorescent screen on which the moving picture appears.

Readers may remember that in October RADIO the statement was made that "the 'big idea' which will ultimately bring radio movies into all the homes

of the land has not yet been conceived, much less perfected." Mr. Farnsworth seems to have found this "big idea." Strangely enough he himself has repeatedly said that narrow-band transmission of moving pictures was impossible. Yet he interrupts himself by actually doing it.

Let it be remembered, however, that a laboratory accomplishment is not a commercial job. Yet it is not impossible within one year's time that a perfected television receiver of this satisfactory type will be on the market and that there will be enough radio movies on the air to justify its purchase.

THE most vital link in the chain of radio merchandising is the retail salesman. No matter how fine the product, how extensive its distribution, how effective its advertising in creating desire and bringing customers to the store,—all is for naught if the retail salesman fails to do his part. Intensive surveys show that customers like to buy where the salesmen are courteous and well informed and avoid stores where salespeople are ignorant and indifferent.

There is no good reason why a customer should know more about the product he is buying than does the man who is selling it. Some radio clerks do not even read the store's advertising. Consequently it becomes necessary for the store management to educate its salespeople with regard, not only to methods of selling, but also to the products which are to be sold.

The necessary information is readily available in the literature supplied by the manufacturers and the radio trade magazines. This magazine has published many fine articles on retail salesmanship during the past year and many stores have utilized them advantageously. They are worthy of careful study.

THE campaign for the elimination of interference to radio reception, as caused by certain domestic electrical appliances, is likely to bring results in the marketing of devices on whose name plates will be stamped such words as "non-radio interfering." The Pacific Court Electrical Association has requested the National Electric Light Association to secure the coöperation of manufacturers in equipping all such devices with suitable filters and in advertising the fact that they will not interfere with radio reception. Furthermore the members of the association are urged to discourage the use and sale of such devices as do cause interference.

In the light of knowledge as to how interference from such devices can be stopped, there is no excuse for the continuance of this nuisance. Frequently a simple condenser across the terminals will suffice. Sometimes more elaborate filters are required. But there are no domestic appliances in which interference cannot be inexpensively squelched.

Satisfactory Radio Movies at Last

Improve Retail Selling Methods

Non-Radio Interfering Appliances

Meet *the* Wife

By LEON W. GABEL

"HERE'S something that has been causing me quite a bit of worry. One of my best men has been falling down on the job. For the last month his sales have decreased until they are almost negligible. Yet he used to be one of the greatest radio sellers in the city. Made records that were almost unbelievable. Lately he's simply gone to pieces and I can't fathom the mystery, try as I will. I've had talks with him, yet they seem to do no good. He won't buck up. He seems to think we don't appreciate his services; that we don't give enough praise to his ability, and, to make matters worse, he's always squabbling about this, that and the other thing. . . . Guess there's nothing left to do but discharge him."

I heard these few remarks from a friend of mine, a sales manager in a large radio shop in a southwestern city. Needless to say, the salesman was discharged.

I was much surprised to find the same salesman working for a rival store in the same city a few months later. He was bright, energetic and full of pep, and evidently holding his own with the best of them. I resolved to ask his new boss about him.

"Yes, I guess you would be surprised to find Fred working here," he laughed. "When I heard that he had been fired, I sent for him, and it didn't take but a few moments to find the source of all of his trouble. I set him to work with our line, and telephoned for his wife. That's where the trouble was."

"His wife!" I exclaimed.

"Yes," he responded with a chuckle.

"At least 40 per cent of all the trouble I've had with salesmen can be traced to their wives' doors. It's funny, I suppose—but just as true as it is funny.

"You know, it has been proved that in every field of endeavor the cases are far and few between in which a successful man's accomplishments cannot be credited to the influence of some woman, whether she is a sweetheart, wife or mother. It's through her initiative and courage in backing the man she loves that he is able to do something worth while.

"Reading biography is a hobby of mine, and this fact was driven home to me long ago, but I never thought that it could be applied right here in my business until a short time ago.

"Take Fred's wife, for example. Fred was a perfect husband, a good provider,

loving and idolized by his wife. To her he was simply the greatest guy that ever lived. She was disappointed that every one else didn't share her opinion, and above all, because she thought his sales manager didn't. She began to sow the seed of discontent in his mind.

"In the majority of cases the wife begins by airing her views to her husband. He ignores them for a while, but constant repetition begins to impress him and soon they become part and parcel of him. He loses his vitality, his work suffers, and soon he is of no use to his organization.

"It's simply a matter of wives, wives and wives. If a man is slipping, the chances are that his wife can put the brakes on him—if she isn't the cause for his slipping."

HERE'S a new thought, I mused, and it set me to speculating as to how many employers thought of this phase of a man's life.

"But," I broke in, "granted this is a valuable point, isn't it a very delicate proposition to handle tactfully?"

"I'll admit," he confessed, "that I made a mess of it the first few times, but someone finally gave me a few pointers about these wives, and with little elaboration I am now able to handle them to perfection.

"When Fred's wife came at my request, after I had taken Fred on, it took me but a few seconds to find out whether I was right or wrong. I could tell that she had a hunch that I knew what it was all about. Another example of a woman's intuition.

"We began with Fred. I praised him highly and had no difficulty in selling her on the idea that she had a marvelous husband and a man. She heartily agreed with everything I said. It was a touchy matter, and I progressed slowly, fearing to put my foot in it.

"We husbands," I told her, "are a lot of babies—big babies—and we have to be babied at all times, in one form or another. I've added Fred to my sales force because I believe, as you do, that he's as good as any radio salesman in this city. But unless he's watched and cared for like a little boy and shown that he has to prove that he's good, the same thing will happen that happened at his other place.

"We talked only a few minutes, but when she left I was firmly convinced that she would do her part. I was right. She has, and now Fred is on the top

rung of our sales force. He'll be leading before long, if the Mrs. pulls for him. This is a wonderful example of what a wife can do, if she pulls in the right way.

"The man with a nagging wife never gets anywhere. I've had an awful job convincing some of these irritable wives on the folly of using their husbands as something on which to exert their tempers. Whenever one of my salesmen begins to slip, I look for the woman behind the trouble.

"These salesmen's wives can make or break them. Through patience and consolation they can give them the pep and fire they need. But nagging and brooding will discourage any man, and the husband in question will begin to slip, and slip quickly.

"A man places all his trust and confidence in the woman he has chosen for his life companion. He comes to her with his grief, expecting consolation, and if he doesn't get it, it's too bad, that's all.

"Naturally he's proud of his wife, and wants to win the world for her, and lay it at her feet. The moment he feels that his wife doubts his ability, he actually will slip.

"Of course, we don't tell these wives how to run their homes. We simply have a friendly talk with them and give them to understand how really important they are to their husbands' success. I honestly believe that most wives don't realize the part they play in their husbands' lives.

"Direct personal contact with an informal, and carefully planned little talk is the best method. Demonstrate to her that she and her husband are engaged in a business—Husband and Wife, Inc.—and that it is up to both partners to contribute their share to its success and happiness.

"Yes, the wives of radio salesmen make or break them."

"By the way," I suggested, before reaching for my hat, "you mention the fact that someone gave you this tip about talking to salesmen's wives to insure their advancement. I wonder if you'd mind giving me his name so that I may have a talk with him?"

"I'll give you the name, but you must promise not to seek the person out.

"In the first place, it wasn't a man."

"You mean a woman told you!" I exclaimed.

"Yes," he answered, "my wife."

NEWS of the Radio Industry

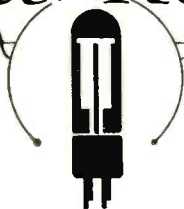

Skip-Trace Advertising

Automobile finance companies in Chicago have speeded collections from "skips" by using display instead of classified advertising. In some cases the delinquent purchasers phoned that the cars would be returned if the advertising were stopped, and in other cases members of a family offered to make restitution rather than have the name disgraced by such publicity. At double the cost, display advertising gave three times the returns received from previous classified advertising. This plan might well be adopted on a cooperative basis by local radio trade associations.

Number of Radios in Use

The estimate by the United States Department of Commerce as to the number of radios in use in the United States is 13,478,600 sets. These are estimated to be distributed as follows:

Ala.	87,700	Neb.	203,000
Ariz.	46,600	Nev.	23,000
Ark.	90,500	N. H.	47,000
Cal.	1,470,000	N. J.	453,000
Col.	172,000	N. Mex.	28,000
Conn.	219,000	N. Y.	1,752,000
Del.	29,000	N. C.	92,000
D. C.	105,000	N. D.	61,000
Fla.	124,000	Ohio	845,000
Ga.	111,000	Okla.	182,000
Idaho	42,000	Ore.	219,000
Ill.	1,060,000	Pa.	977,000
Ind.	348,000	R. I.	111,000
Iowa	310,000	S. C.	44,000
Kan.	195,000	S. D.	77,000
Ky.	92,000	Tenn.	104,000
La.	121,000	Texas	364,000
Maine	80,000	Vt.	45,000
Md.	115,000	Va.	114,000
Mass.	656,000	Wash.	351,000
Mich.	627,000	W. Va.	86,000
Minn.	239,000	Wis.	322,000
Miss.	48,000	Wyo.	32,000
Mo.	433,000		
Mont.	54,000	Total	13,478,600

Radio Interference Film

"Radio Interference"—a one thousand foot moving picture, both silent and in sound, has been produced by the Radio Interference Association of California through courtesy of the Tobe Deutschmann Corporation of Canton, Massachusetts, Filterette Division.

Radio clubs, service organizations, cities and towns may obtain the use of this picture by writing the Tobe Deutschmann Corporation direct. A qualified interference engineer is available to address such assemblies.

Langmuir Tube Patents Sustained

The U. S. Circuit Court of Appeals at Philadelphia has sustained the Langmuir patent on the construction of vacuum tubes in a suit brought by the General Electric Company against the De Forest Radio Company. This decision reverses the decision of a lower court and will be appealed to the supreme court.

Sparton Custom-Built Sets

Sparton radio has arranged to take the output of a guild of wood carvers in Brussels, Belgium, to be used as the housing for the Sparton chassis. While a number of period cabinets will be carried for delivery from the factory, most of this class of business is to be in the form of custom-made cabinets in accordance with the buyer's specifications.

New Columbia Combinations

Columbia Phonograph Company, Inc., New York City, announces two new models: No. 939 combines an electric phonograph and radio and No. 991 also has an automatic record changer. The radio of No. 939 employs '24 tubes in the three r-f and power detector stages, a '27 tube in the first resistance coupled audio and two '45 tubes in the push-pull output stage, with '80 rectifier. It

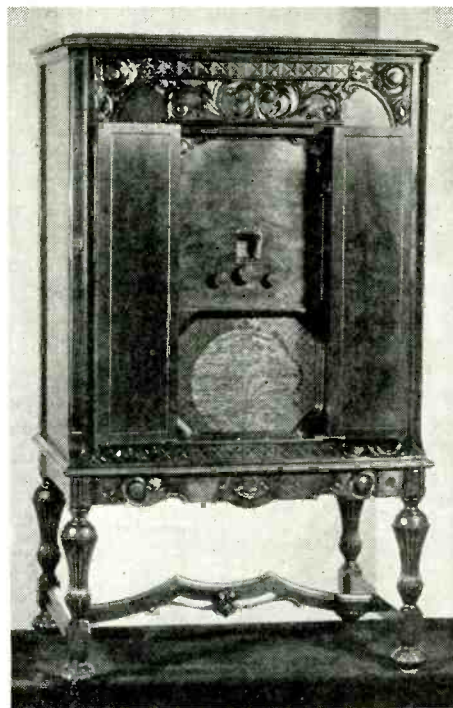

Columbia Model 939

RADIO FOR DECEMBER, 1930

has automatic volume control and tone level, local-distance switch, and electrolytic condenser. The speaker is a 7½ electro-dynamic. The phonograph is a 12-inch, electric driven turn-table with an improved pick-up. The walnut cabinet is English in type with two 22-record bins. It lists at \$235 less tubes.

No. 991 has a similar radio chassis, speaker and phonograph with the addition of automatic changer handling nine records. The bin has a capacity of fifty records. It lists at \$325 less tubes.

Atwater Kent Salon

The D'Elia Electric Company, Bridgeport, Connecticut, Atwater-Kent distributor, have rented vacant stores in various towns throughout their territory, fitted them up attractively, and supplied a trained salesman who cooperates with and trains a dealer's salesman. Each dealer in the town operates the salon for one day, profiting from all floor sales and having all prospects for follow-up.

Eveready Air Cell "A" Battery

National Carbon Company expects to have the new 2-volt air cell battery available through the regular channels of distributors early in 1931. Distribution of samples is being confined to manufacturers who are proving its suitability for use with 2-volt tube sets in unwired homes. Such tubes draw their rated filament current at 2.1 volts. Tests with a 7-tube receiver using three screen grid, two general purpose, and two output tubes, have shown that the battery's initial 2.53 volts is maintained for 1000 hours service, with a drop from 2.5 to 2 volts during an additional 100 hours. To secure 1000 hours service, with drops from 3 to 1.9 volts, requires four sets of eight standard dry cells, each with its complicated series multiple connection and costing about twice as much as an air-cell battery, which has only two terminals.

New Screen-Grid Tube for Midgets

The De Forest Radio Company, Passaic, New Jersey, is producing a special screen gride tube for use in midget sets. It is known as the De Forest 424 high gain audion. It is interchangeable with the standard '24 tube, but has a higher amplification constant which is claimed to double the sensitivity of the average midget set.

New Radio Equipment

New Clarion Models

Transformer Corporation of America has started production on new Junior and Minuet models of Clarion radio. These sets are seven tubes including push-pull '45s in the last audio stage. The four tuned circuits are claimed to give a 15-kilocycle separation. The cabinets are of Oriental walnut.

Weston Volt-Ohmmeter

Weston Electrical Instrument Corporation announces Model No. 564 as a compact and inexpensive (\$28.13) instrument for measuring voltage and resistance and testing continuity. The meter is a d-c Model 301 with four voltage ranges (600/300/30/3 volt, all 1000 ohms per volt) and two resistance ranges of 0-10,000 and 0-100,000 ohms.



Weston Volt-Ohmmeter

All ranges are brought out to binding posts; one toggle switch connects the meter in circuit as a voltmeter or ohmmeter and another changes the sensitivity from 1 to 10 m.a. when using the 100,000 or 10,000-ohm scale. The instrument contains a C battery and is provided with a pair of 30-inch cables with test prods.

Weston Tester

Weston Model 566 is a 2-meter set tester for checking all types of tubes under the conditions existing in the radio set and for making all the usual external tests. The meter is a 9-range a-c Model 476 controlled by a dial switch and a 10-range d-c Model 301



Weston 2-Meter Set Tester

controlled by a 23-point bipolar switch. The a-c meter gives readings for 1000, 200, 16, 8, 4 volts, 8 and 4 amperes, and 100 and 20 ma. The d-c meter indicates 1000, 250, 100, 25, 10 volts, 100,000 and 10,000 ohms, and 100, 25 and 2.5 ma. The tube sockets are UX and UY; adapters may be obtained for various large and small UV tubes. External readings are secured through binding posts, leads and tester plug. The net price to dealers is \$78.75 f.o.b. Newark, New Jersey.

Mayo Replacement Parts

Mayo Laboratories, 281 East 137th Street, New York City, has announced a new and complete line of replacement parts which includes transformers, condenser blocks, and wire wound resistances for all of the standard makes of sets. These are made in the duplicate of the original as far as external appearance, size and hook-up is concerned.

New Super-Davohm

The Daven Company, Newark, New Jersey, announces a new Super-Davohm wire-wound resistance with tinned wire terminals, with either both at one end or with a terminal at each end. The winding is non-inductive and has a minimum distributed capacity. The various resistor values are accurate to within ± 1 per cent, the temperature co-efficient being practically nil. The spools are non-hygroscopic, being made of lava and isolantite, with an insulated clearance for a No. 6 screw.



New Super-Davohm

Silver-Marshall Short-Wave Converter

Silver-Marshall, Inc., Chicago, have designed the S-M 738 to convert any broadcast receiver into a short-wave superheterodyne. A single dial tunes the oscillator circuit and an auxiliary mid-geet condenser. Operation is greatly simplified by the absence of any critical regeneration control. Included in the factory-wired outfit, which sells for \$69.50, are four pairs of coils to cover the range from 18 to 206 meters. It requires a '24, a '26 and a '27 tube.

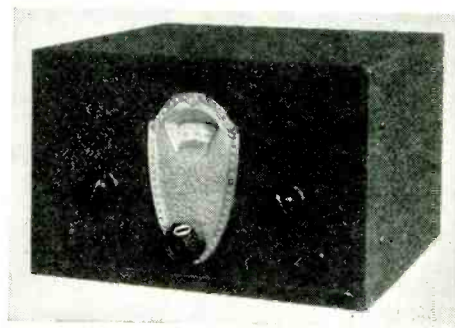

Silver-Marshall short-wave converter

Gulbranson Minuet

This is a compact receiver in end table form, 23 inches high, 14 inches wide and 22½ inches deep. The cabinet is finished in Oriental walnut and can be easily moved. It requires three '24 tubes, one '27, two '45s and one '80. The price is \$81.75, less tubes.

Model 19 Supreme Tube Checker

This new model with 3½-inch G. E. disc-rectifier meter is supplied for either counter or portable use. It provides an accurate test of all types of tubes, including pentodes, at the correct filament voltages, and without the aid of adapters, six sockets being provided to hold various a-c and d-c tubes. Average characteristics and rejection points are indicated on the panel alongside of each socket. It gives plate current readings, mutual conductance, and grid test on amplifiers, as well as screen grid operating tubes. It has full-sized transformers and operates from the 110-volt a-c circuit, all tube circuits being isolated from the power circuit. The meter has an 8 and an 80 mil scale. The counter model is priced at \$26.95 and the portable at \$29.95 net to the dealer.

ASSOCIATION NEWS



The annual convention and trade show of the Radio Manufacturers' Association in 1931 will be held in some middle western city and during the first or second week in June. Business, without ballyhoo, will be the keynote of the 1931 gathering of the radio industry. To insure exhibition of new and current radio merchandise all exhibitors will be required to show their new or current receiving sets and other radio lines. Another new rule will permit exhibition, not in the show but in the demonstration rooms of exhibitors, of associated radio products made by manufacturers in addition to receiving sets, etc.

Local public radio shows which are held annually in many cities hereafter will be conducted without the sponsorship or endorsement of the Radio Manufacturers Association. While the manufacturers recognized the local trade value of such public radio shows, in trade promotion sales, etc., the manufacturers decided to withhold any official connection with such public radio exhibitions. The RMA hereafter will refer all requests for endorsement or sponsorship of local public radio shows to the proper national or local organizations of radio distributors.

Two new directors elected to the RMA board at its meeting, November 18, in Cleveland, were Eugene R. Farny of the All-American Mohawk Corporation of North Tonawanda, New York, and A. S. Wells of the Gulbransen Company of Chicago. They were elected to fill vacancies caused by the resignations of Lester E. Noble of Springfield, Ohio, formerly of the United Reproducers Corporation, and John C. Tully of Chicago, formerly of the Bremer-Tully Company, both of whom are not now actively identified with the radio industry.

Preparation of merchandising bulletins to be circulated by the RMA to the trade is contemplated. These would provide for an exchange of information on current sales and other conditions and enable manufacturers to keep in closer contact with the actual public demand for radio products. Chairman Jackson and the Merchandising Committee also are considering a series of bulletins to radio jobbers to supplement but not duplicate the jobber and dealer service of individual manufacturers. Issued under the authority of the RMA and representing a consensus of manufacturing opinion in the stimulation of radio sales, both by the jobber and the dealer, it is believed that the plan under consideration will accomplish much in developing not only better merchandising practices in radio distribution, but be of direct assistance to jobbers and dealers.

Radio Interference

A plan for cooperation between radio manufacturers to reduce the interference troubles of the radio public has been adopted and will be carried on through a special Interference Section of the RMA Engineering Division. Later it is planned to enlarge the interference service for the owners of radio receiving sets by the establishment of a separate bureau in the RMA for such interference work, under the direction of competent engineers.

Joint action by the radio industry on copyright legislation now pending in Congress is being taken, to protect the interests of broadcasters, manufacturers and the trade. A joint committee of the National Association of Broadcasters and the Radio Manufacturers Association met November 18 at Cleveland and agreed on many amendments to be presented to Congress by the united radio interests. The Copyright Bill is designed to determine the royalties on music, dramatic and other productions which are broadcast or reproduced on records. The copyright legislation is in charge of the respective chairmen of the NAB and RMA legislative committees, Henry A. Bellows of Station WCCO of Minneapolis, and C. C. Colby of the Samson Electric Company of Canton, Massachusetts.

The Amplifier Section of the Standards Committee of the RMA Engineering Division will develop standardized ratings for power amplifiers and also cooperate with the National Board of Fire Underwriters in drawing up a satisfactory set of standards covering amplifiers. Export trade in amplifiers and traffic, statistics, legislative and other interests of amplifier manufacturers also will be specially developed by respective RMA committees. Chairman Kleckner reported that the amplifier group of the RMA already includes the following companies: Samson Electric Company; Pacent Reproducers Corporation; Rauland Corporation; Webster Company of Chicago; Polymet Manufacturing Company; Silver-Marshall, Inc.; Operadio Manufacturing Company and the Webster Electric Company.

Bond Geddes, executive vice-president, RMA, estimates that pre-Christmas sales of radio products will amount to over \$150,000,000. He urges the trade to assist in the "buy now" campaign by using the football broadcasts and other premiere broadcasting events as a sales stimulus.

George Lewis, chairman of the RMA Vacuum Tube Committee, is directing the "life test" subcommittee, of which George Rishell is chairman, in a study of the reasons why tubes fail. The purpose is to find means for prolonging the useful life of tubes.

The National Federation of Radio Associations and the Radio Wholesalers Association have withheld publication of their booklet on establishment of an interference department until such time as complete data is available. It is felt that the elimination of interference can best be handled through local associations. The two years' experience of the Pacific Radio Trade Association in minimizing interference will form the basis for the recommendations in the future booklet. Certain modifications may be made as the result of similar work to be carried on in the Chicago area.

A new suggested Code of Business Practices for Radio Dealers is to be approved at the December meeting of the Radio Wholesalers Association.

The fifth annual convention of the National Federation of Radio Associations and the Radio Wholesalers Association will be held February 16 and 17, 1931, at Indianapolis, Ind.

PERSONAL MENTION

W. A. Bannon is now advertising manager for the Gulbransen Company of Chicago. During the past nine years he has been doing sales promotion and advertising work for Brunswick, Kellogg and Copehart.

T. H. Phillips, formerly Fada representative in the Southwest, now represents the Lyric radio at Dallas, Texas.

H. Curtiss Abbott, at one time sales manager of the National Carbon Company's radio division and recently Pacific Northwest manager for Philco, has become West Coast division manager for the All American Mohawk Corporation.

W. J. Pohlman, formerly Zenith's publicity director, is now in charge of Brunswick advertising and sales promotion in the Chicago district.

Ernest H. Vogel has been advanced from the position of advertising and sales promotion manager of the Radiola Division of RCA Victor Company to that of sales and advertising manager.

D. P. Dewell has succeeded A. M. Kennard as advertising manager for Columbia Phonograph Company, Inc., New York City.

Carl Main, 560 Arden Road, Columbus, Ohio, is the new Sparton representative for New York State, exclusive of New York City, and parts of New Jersey and Pennsylvania. George Valentine and Robert Billingsley are covering the southeastern states since the death of Cannon Forbes.

R. C. James has been appointed sales representative for the Ward Leonard Electric Company, at 2321 Second Avenue, Seattle, Washington.

NEW RADIO CATALOGS

National Company, Inc., Malden, Mass., is distributing a new booklet which gives detailed information regarding the MB-30 tuner and the VSA amplifier. The former is a five-tube chassis, for '24s and one '27, designed for extreme sensitivity and selectivity without cutting of side bands. The latter is a two-stage audio amplifier and power unit with electrodynamic speaker which gives unusual uniformity of reproduction.

Jewell Electrical Instrument Co., Chicago, has published an interesting sixteen-page pamphlet on Testing Instruments for manufacturers of radio receivers, parts, and electronic tube equipment. These include ohmmeters, bridges, voltmeters, tube checkers, condenser checkers, and test panels.

Selling Side Lines

(Continued from Page 18)

The items mentioned thus far are those which have been most prominently featured as side lines for radio dealers. They by no means exhaust the list. In

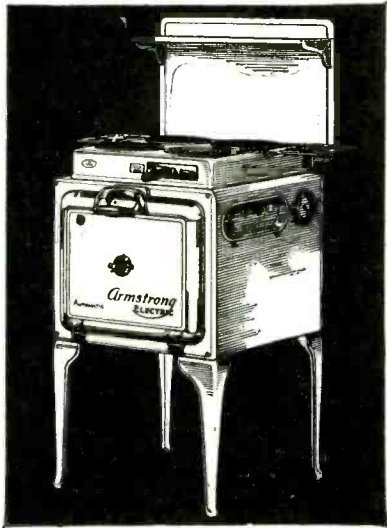

Electric Ranges Make a Good Side Line

fact, a radio dealer is justified in selling anything from lamps to oil-burners which offers a sufficient margin of profit or can be sold in sufficient volume to help pay his overhead.

But in taking on a side line no radio dealer should slacken in his efforts to sell radios. It still offers a greater sales opportunity than does any known side line. Other industries have suffered as much or more than has the radio industry during the past year. Auto sales,

for all except cheap cars, have been less than half normal. In spite of the tremendous publicity that has been given to aviation less than 3000 planes have been sold this year. All concerns which distribute their product by house-to-house canvassing have experienced the worst year in a decade.

These facts are not presented as a deterrent but merely as a warning not to let go of radio in order to take on some other line. Half the homes of the country are still without a radio set and millions of others are still using old sets which should be replaced by new models. Especially should there be no relaxation in efforts to sell radio tubes.

It is no harder to sell radio sets, tubes or service than it is to sell any of the side lines listed. After a set has been sold the buyer is a prospect, however, not only for tubes and servicing, but also for some other device. If the dealer handles such a device he can sell it to

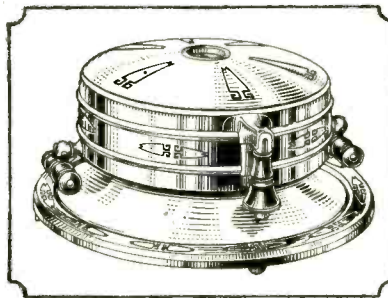

Electric Waffle Irons Sell Well

customers whose friendship he has earned by giving the satisfaction which should follow every radio sale. Diversification in selling is a good policy, but keeping everlastingly after what you have is a better one.

the price and advantage of different "seats" in the air theatre.

What good roads have done for the automobile industry, good programs will do for the radio receiving set sales. Recent improvements in broadcasting have done for radio set sales what increased mileage of roads has done for increased automobile sales. Not everyone realizes the full extent of either. Salesmen must tell them.

Furthermore, Roger Babson estimates that there are between 6,000 and 7,000 new customers for every commodity every day. That is, about 6,500 boys or girls reach the voting age, the marrying age, the home buying age every day. As each year adds to life, people have new viewpoints, look at things differently, are interested in things today that did not interest them yesterday. Retail salesmen are the final link in the chain that must tell these new prospects all about good radio programs.

PROFIT PROMOTION

(Continued from Page 27)

tribute, and how much each member of the sales force is to contribute. We simply lay out two roads to the same goal; and we find the benefits increasing constantly as the work continues thoughtfully year after year.

A Few Additional Quota Comments

THE time period is an essential consideration in every sales quota. Here, again, divisions and subdivisions are applied with marked advantage.

When our fundamental profit-making plan has been worked out for the year ahead, we first check it up by determining how much each month of the year should contribute. Then, working on a monthly basis, we can set our pegs according to weeks, and sometimes even according to days, depending always upon the judgment of the individual manager.

Adjustments are absolutely necessary. First, to make the divisions harmonize with the whole; second, to meet the inevitable variation in the conditions that influence business. The big point is to work always with a definite goal clearly in view, and to set that goal as nearly right as possible on the basis of existing and probable conditions.

No one can hit it exactly right (except by accident), because quota-setting is not an exact science. Besides, the major benefit comes not from getting the quota exactly right, but from trying to get it as nearly right as possible. That means, of course, constant striving for improvement.

(All rights reserved)

[Editor's Note: Mr. Koch's profit-promotion lesson in the next issue of RADIO will be on "Better Control of Merchandise Stocks." While each lesson is complete in itself, a careful review of preceding lessons from time to time will help to make the entire course much more helpful to radio dealers.]

What Radio Salesmen Should Know About Broadcasting

(Continued from Page 24)

subscriptions and sales. If the news, editorials, stories, etc., in any newspaper is not interesting, the public does not buy or read the publication. The greater the number of readers, the higher can be the advertising rates. Likewise, with radio broadcasting, the better radio programs are, the more listeners; hence the greater value the station has to an advertiser.

In 1928 some 80% of advertisers on large chains dropped out during the summer. In 1929 only about 20% dropped out. And in 1930 only about 10% dropped out or deliberately planned contracts so that they would be off the air during summer months. Hard-boiled advertisers would be the first to stop summer advertising if there were

not a large audience to hear their programs.

Try to imagine how this country could be run without the service of newspapers. Today, if all radio broadcasting were stopped, the people would cause such a disturbance that Congress would soon find means to provide radio program service. There are still too many stations in some localities, and not enough in others; but that condition will be corrected and the air over every spot in the country will be full of wonderful radio programs of entertainment and useful information available to everyone with the "price of a seat of some kind to hear the show." The successful radio receiver salesman will know how to sell the show as well as know



Keep in Display! Carton of four Eveready Raytheon B-H Tubes.

REMINDE CUSTOMERS! OF EVEREADY RAYTHEON B-H TUBES FOR "B" ELIMINATORS

TELL CUSTOMERS what a marvelous improvement in reception a new B-H rectifying tube will make. You have no idea how great your local market for replacement is until you systematically begin to cultivate it.

Most "B" power units are designed for the B-H tube . . . the original gaseous rectifying tube. Millions of these units have been sold in the past few years.

Eveready Raytheon B-H Tubes are their own best salesmen—get one in a unit, it does the rest!

They come in handy four-tube cartons. Always have a full carton on display! Increase your replacement business.

* * *

The Eveready Hour, radio's oldest commercial feature, is broadcast every Tuesday evening at nine (New York time) from WEAf over a nation-wide N. B. C. network of 27 stations.

NATIONAL CARBON CO., INC.
General Offices: New York, N. Y.
Branches: Chicago Kansas City
New York San Francisco
Unit of Union Carbide



and Carbon Corporation



Trade-marks

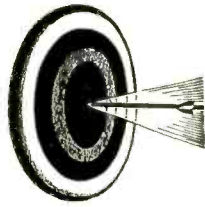

BULL'S EYE! Control does it

THE shaft sinks into the gold up to the feathers. Muscle alone will not do it. . . . It's all in the CONTROL.

Just so you need proper Control in your radio set to deliver a noiseless, smooth increase in power to get bull's eye radio reception.

In millions of sets Centralab controls are giving a superlative service.

NOW . . . for the first time complete data for Servicemen and Dealers. The new VOLUME CONTROL GUIDE is now ready for distribution.

Send 25c to Dept. 103-A for this informative booklet. Gives Volume Control data and circuits for practically every old and new set. Tells how a small stock of Centralab controls will enable you to give immediate service on almost all sets.

Write Dept. 103-A for new bulletin on Controls for Projection Apparatus.

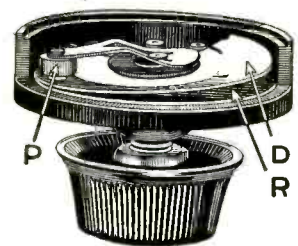

This shows the exclusive rocking disc construction of Centralab volume control. "R" is the resistance. Contact disc "D" has only a rocking action on the resistance. Pressure arm "P," together with shaft and bushing, is fully insulated.

Centralab

CENTRAL RADIO LABORATORIES

Dept. 103-A

14 Keefe Avenue

Milwaukee, Wis.

Tell them you saw it in RADIO

ARE YOU Penny Wise?

YOU have often heard it said, "Don't be penny wise and pound foolish." And yet it so natural. Another tendency is to procrastinate. Do you recall the fellow who explained why he did not repair his leaky roof? He said, "I can't mend it when it is raining and when it stops raining, the roof doesn't leak." How many business roofs are leaking now because they were not mended while skies were clear and business was good?

Among "penny wise" people are some Radio Wholesalers. When times are good, they are too busy to find out what a good investment membership in the Radio Wholesalers' Association would be. They take an indifferent attitude. When there is a business depression, then they practice a "penny wise" policy by saying they cannot afford the price of membership.

The Radio Wholesalers' Association was organized and functions for the benefit of the entire radio industry, from manufacturer to consumer. It safeguards the best interests of the Radio Wholesaler and Dealer. Its membership represents a majority of the purchasing power of the country from Radio Manufacturers.

The annual convention of the Radio Wholesalers' Association will be held in Indianapolis on February 16-17, 1931, and will be a "down to facts and remedies" convention. Rub elbows with the fellows who will not be "licked."

Join the Radio Wholesalers' Association, Mr. Radio Distributor—don't be "penny wise," especially in these times. Don't indulge in "false economy." Write for information regarding membership and plan now to attend the convention in Indianapolis.

RADIO WHOLESALERS' ASSOCIATION

H. G. ERSTROM

Executive Vice-President

EXECUTIVE OFFICES:
32 West Randolph Street
CHICAGO, ILL.

The New LEACH Ultra-Sensitive RELAY

FOR light sensitive cell work, recording radio signals, burglar alarms, fire alarms, indicators, etc.

Will operate in excess of 100 words per minute on an input of ONE MILLIAMPERE. Will also operate on as low as 200 MICRO-AMPERES.

Will stand a floating current of three or four milliamperes on the winding and operate on a variation of this current.

Easily adjusted, reliable in operation, internal resistance 1,000 ohms, finished in polished nickel, not affected by ordinary vibration and will operate in any position.

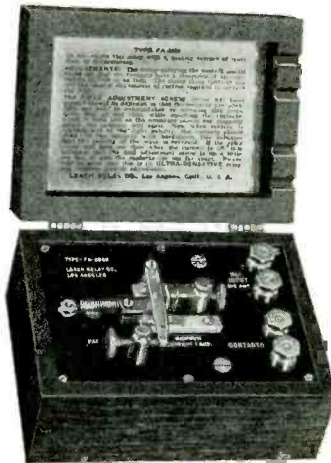

TYPE FA-2630

Price \$22.50

LEACH RELAY CO.

860 So. Los Angeles Street
LOS ANGELES, CALIF.

WEBSTER'S NEW INTERNATIONAL DICTIONARY

is the "Supreme Authority"

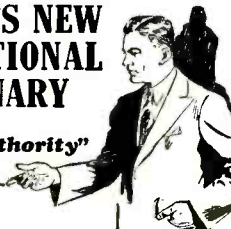

EVIDENCE

Hundreds of Supreme Court Judges concur in highest praise of the work as their authority.

The Presidents and Department Heads of all leading Universities and Colleges give their indorsement.

The Government Printing Office at Washington uses The New International as the standard authority. High officials in all branches of the Government indorse it.

The Colleges voted overwhelmingly in favor of Webster as standard of pronunciation in answer to questions submitted by the Chicago Woman's Club.

Get The Best

Send for free illustrated booklet



A Library in One Volume

Equivalent to a 15-volume encyclopedia. 2,700 pages; 452,000 entries, including thousands of NEW WORDS; 12,000 biographical entries; 32,000 geographic subjects; over 6,000 illustrations. America's Great Question-Answerer.

G. & C. MERRIAM COMPANY
Springfield, Mass.

STATEMENT OF OWNERSHIP, MANAGEMENT, CIRCULATION, ETC., REQUIRED BY THE ACT OF CONGRESS OF AUGUST 24, 1912.

"RADIO," published monthly at San Francisco, Calif., for October 1st, 1930.

State of California, County of San Francisco, ss.

Before me, a Notary Public in and for the State and county aforesaid, personally appeared H. W. Dickow, who, having been duly sworn according to law, deposes and says that he is the Business Manager of "RADIO," and that the following is, to the best of his knowledge and belief, a true statement of the ownership, management, etc., of the aforesaid publication for the date shown in the above caption, required by the Act of August 24, 1912, embodied in section 411, Postal Laws and Regulations, printed on the reverse of this form, to-wit:

1. That the names and addresses of the publisher, editor, managing editor, and business managers are:

Publisher, Pacific Radio Publishing Co., Pacific Bldg., San Francisco; Editor, Arthur H. Halloran, Berkeley, Calif.; Managing Editor, None; Business Manager, H. W. Dickow, Pacific Bldg., San Francisco.

2. That the owner is:

Pacific Radio Publishing Co., Pacific Bldg., San Francisco; Arthur H. Halloran, Berkeley, Calif.; H. W. Dickow, Pacific Bldg., San Francisco; H. L. Halloran, Berkeley, Calif.

3. That the known bondholders, mortgagees, and other security holders owning or holding 1 per cent or more of total amount of bonds, mortgages, or other securities are: None.

4. That the two paragraphs next above, giving the names of the owners, stockholders, and security holders, if any, contain not only the list of stockholders and security holders as they appear upon the books of the company, but also, in cases where the stockholder or security holder appears upon the books of the company as trustee or in any other fiduciary relation, the name of the person or corporation for whom such trustee is acting, is given; also that the said two paragraphs contain statements embracing affiant's full knowledge and belief as to the circumstances and conditions under which stockholders and security holders who do not appear upon the books of the company as trustees, hold stock and securities in a capacity other than that of a bona fide owner and this affiant has no reason to believe that any other person, association or corporation has any interest, direct or indirect, in the said stock, bonds, or other securities than as so stated by him.

H. W. DICKOW,
Business Manager.

Sworn to and subscribed before me this 2nd day of October, 1930.

(SEAL) JOHN L. MURPHY,

Notary Public in and for the City and County of San Francisco, State of California. My commission expires May 20, 1933.

OFFICIAL RADIO LOG



A most complete and up-to-date call book—not printed in periodic runs, but kept accurate in every respect, at all times—contains just the information radio fans demand—good for advertising or resale.

Write today for sample and quantity prices

All American Service
SPECIALISTS IN DEALER HELPS
5707 N. Clark Street
CHICAGO, ILL.

NEW



Weston MODEL 566

*Low price test set for
radio servicing*

THIS new Weston test set is designed for radio service men and dealers who specialize in servicing radio receiving sets in the home.

These men will find this new two meter test set ideally suited for their requirements because it combines the highly desired Weston dependability of operation with low cost.

Servicing Scope

Weston Model 566 checks all type tubes under the same conditions as exist when in their sockets, giving readings quickly, conveniently, and accurately. Model 566 furnishes adequate measurements for testing all models of receiving sets—checking power transformers; line voltage; heater voltage, and plate current and voltage at power pack; battery voltages, resistance and continuity of circuits, condensers and speaker coil currents.

Equipment

Model 566 contains two 3¼ inch standard high quality Weston meters with scales specially calibrated for convenience and ease in reading. The meter on the left is a nine range A.C. Model 476 for 1,000/200/16/8/4 volts, 8/4 amperes, and 100/20 milliamperes. The meter on the right is a 10-range D.C. Model 301 for 1,000/250/100/25/10 volts, 0-100, 000/0-10,000 ohms and 100/25/2.5 milliamperes. The various ranges of the D.C. Volt-ohm milliammeter are controlled by a 23 point Bi-polar switch. The ranges of the A.C. meter are controlled by a dial switch. A polarity reversing switch is provided; also binding posts, leads and tester plug for use in taking external readings.

{ For more complete information write for Circular HH }

PACIFIC COAST REPRESENTATIVES
 Graybar Electric Co., Inc. 84 Marion St. Seattle, Wash.
 J. H. Southard San Francisco, Calif.
 A. A. Barbara Los Angeles, Calif.
 Repair Service Laboratory 682 Mission Street San Francisco, Calif.

Weston
 PIONEERS SINCE 1888
INSTRUMENTS
 WESTON ELECTRICAL INSTRUMENT CORPORATION
 600 Frelinghuysen Ave. Newark, N. J.



WHAT ARE 1931 TUBES?

It's easy to identify 1931 tubes among the general run of tubes. Meters and performance rather than labels and claims soon separate the sheep from the goats. Briefly, and for your guidance, the 1931 radio tube features are:

- Positive Characteristics* because of the doubling of the diameter of some support wires and better bracing, together with tightened tolerances.
- Improved Tone Quality* resulting from greater rigidity and therefore minimum microphonic effects, together with suppression of distortion arising from undesirable regeneration.
- Quiet Background* brought about by DeForest research into causes of hum and crackle, resulting in one-fiftieth the noise level heretofore considered standard practice, together with lower gas content made possible by unique DeForest exhaust units now in use.
- Longer Service Life* brought about by important improvements in filaments, cathode insulators and emitters, insuring full thousand hours of peak efficiency.
- Greater Volume* through the increase of the mutual conductance in power tubes, yet maintaining full interchangeability with usual tubes of lower output.
- Quick Heating* averaging about 10 seconds, due to patented DeForest notched cathode insulator, without sacrificing life, reliability or quiet operation.
- Higher R.F. Amplification* with screen-grid tubes, or 60 instead of usual 30 per stage, while decreased grid-plate capacity permits of maximum stability or minimum regeneration for the highest gain with least distortion.

The foregoing 1931 radio tube features are not to be found in tubes produced six months ago, much less those a year or two old, taken from large inventories. DeForest research and engineering, rapidly translated into everyday terms by a production geared to the demand, brings these features to you in fresh.

DeFOREST RADIO CO. *de Forest* AUDIONS PASSAIC N. JERSEY
RADIO TUBES

OFFICIAL SERVICE MANUAL
 352 PAGES + 1000 ILLUSTRATIONS
 The Ideal Book for Dealers and Service Men
 "RADIO," Pacific Building San Francisco **\$3.50** PER COPY

Radio's Biggest Values
 Up-to-the-minute offerings at lowest wholesale prices. Includes newest Tone Control, Screen Grid Superheterodyne, Radio-Phonograph combinations, short wave receivers, automobile radios, public address. Attractive walnut consoles and latest accessories, parts and kits. Don't buy until you see our big catalog.
Send for FREE Complete Catalog
 Western Radio Mfg. Co. 128 W. Lake St. CHICAGO

Genuine Factory Replacement Parts
 for PEERLESS - COURIER - KYLELECTRON ARBORPHONE RADIO SETS AND SPEAKERS
 COMPLETELY EQUIPPED LABORATORY FOR SERVICE ON ALL SETS SCHEMATIC DIAGRAM FOR ALL MODELS 50c
 Factory Service Division for the Former United Reproducers Company of Ohio
The Gray Electric Co.
 SPRINGFIELD, OHIO
 Established 20 Years

Tell them you saw it in RADIO

PROFIT on Merchandise Bought During Past "Bad" Times

Low Prices on Replacement Condensers, Transformers, Speakers, Chokes and other numerous items. Special low discounts on nationally known standard equipment.

Readrite AEROVOX Faradon Webster de Forest
 DIRECTOR: Unipower PROBORSON
 EXTRA EXTRA
 Guaranteed Merchandise
 ORDERS SHIPPED SAME DAY RECEIVED
American SALES COMPANY
 18-21 Warren Street NEW YORK CITY
 Take Advantage
 REAL MONEY MAKERS
 Radio and Electrical Wholesale Bargain Bulletin No. 66
 If you are not on our mailing list, write us at once.
 Contains over 1000 items that will make business good for you.
 Graybar KOLSTERS SUPER ALUMINUM CRYN
 Western Electric POWERIZER FLECHTHEIM BEVIE JEWELL

AMERICAN SALES CO.

0-21 Warren Street New York City

AIREX
 RADIO BUYERS' GUIDE
 WORLD WIDE SERVICE
 DEALERS! SERVICE MEN!
 Write for Catalog
The AIREX CO.
 76 Cortlandt St.
 NEW YORK CITY

DEALERS AND SERVICEMEN

SEND FOR IT TODAY!

FREE!

RADIO DEALERS SET BUILDERS AGENTS SERVICEMEN OUR BARGAIN BULLETIN IS WAITING FOR YOU

This COUPON means MONEY for YOU

BALTIMORE RADIO CORPORATION
 47 Murray St. New York City Dept. P.R.

Gentlemen: Kindly send me your latest Bulletin.

Name _____
 Address _____
 City _____ State _____

Radio Bargain News
 ESTABLISHED 1921
 BUY FOR CASH AND SAVE HALF
 Write for Your FREE Copy of this BIG Catalog 40 PAGES OVER 1,000 ITEMS OF REPLACEMENT PARTS FOR ALL STANDARD SETS

Free **Write Now**

Federated Purchaser
 22-B Hudson Street
 New York City, N. Y.

HOTEL
Greystone
BROADWAY
at 91st STREET
NEW YORK

A modern, three million dollar building, overlooking the Hudson; Subway Station at door; 10 minutes from shopping and theater center.

500 ROOMS · 500 BATHS
Single from \$3.50 Double from \$5.00
SPECIAL WEEKLY RATES

Now under the management of
CARL SWORD

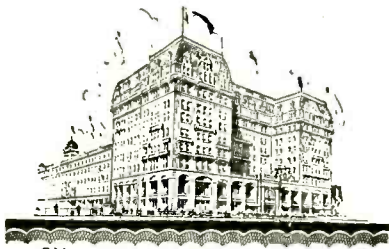

ON THE OCEAN FRONT

The
Breakers
ATLANTIC CITY N.J.

Preferred—

In all seasons by those who know and wish the best upon either the American or European Plan.

*Bathing from Rooms
Sensible Rates Withal!*

HILLMAN MANAGEMENT

**REPLACEMENT
SPECIALISTS**

Power amplifier transformers for 250 tube and 2-281 tubes	\$3.25
Double 30 henry choke, 125 mill, 500 ohms, each	\$1.15
Tip jacks, each	\$.04
Phosphur bronze drum cable, per foot	\$.07

FREED RADIO
SALES & SERVICE

16A Hudson Street New York City

BINDERS

For preserving your copies of "Radio"
\$1.00 Postpaid

PUBLISHERS OF "RADIO"
Pacific Building San Francisco

RADIOADS

A Classified Advertising Section Read by Better Buyers

Discontinued Merchandise and Job Lot Advertising Must Be Plainly Indicated as Such
RATES: 8 CENTS PER WORD
\$6.00 PER DISPLAY INCH
Remittance Must Accompany All Ads
Radioads for the January Issue Should Reach Us by January 1st

BUSINESS OPPORTUNITIES

STARTLING INVENTION! SCREW-HOLDING SCREWDRIVERS! Remove, insert screws inaccessible places! Factories, garages, electricians, mechanics buy on sight! Sells \$1.50; exclusive territory. **FREE** trial! Toolco, 1592 Water St., Boston.

BARGAINS! BARGAINS! BARGAINS!

Our new "Bargain Bulletin" contains many items at prices that will astound you. Send for it today. It will save you money! Harrison Radio Co., Dept. P, 189 Franklin St., New York City.

POWER PACK REPAIRING

WHOLESALE RADIO SERVICE. Power Pack rebuilding, Shop equipment built and repaired, Coils matched, All kinds of Solenoid winding, B & B Radio Lab., 509 Terry Ave., North, Seattle, Wash.

POWER PACK SERVICE and transformer winding. Quick service and fair prices for all types of power transformers and chokes. Condenser blocks replaced. Guaranteed work. California Radio Laboratories, 2523 South Hill St., Los Angeles, Calif.

COMPLETE POWER-PACK SERVICE— Transformers rewound, Condenser blocks repaired, Resistors repaired or duplicated. Specially equipped shop. Work guaranteed. Clark Brothers Radio Co., Albia, Iowa.

POLYMET 8 mfd. 430 volt working voltage electrolytic condensers, latest type, inverted or upright. \$1.35 each, plus postage. Weight, packed, 1 1/4 pounds. California Radio Laboratories, 2523 South Hill St., Los Angeles, Calif.

110 VOLT ELECTRIC WAFFLE IRON given FREE this month to any subscriber to "RADIO" who extends his present subscription for two more years. Full price for the subscription and the waffle iron, \$4.00. Offer good for 30 days only. Money refunded in full if you are not convinced that this is the best offer we ever made. Publishers of "RADIO," 428 Pacific Bldg., San Francisco, Calif.

LIFE TIME GUARANTEED 110 Volt AC 60 cycle electric clock FREE this month with an extension of your subscription to "RADIO" for 3 years more. Send \$6.00 in full payment for the subscription and one electric clock. This clock is in genuine bakelite case and is ideal for office, store or home use. Publishers of "RADIO," 428 Pacific Building, San Francisco, Calif.

WHOLESALE DISCOUNTS. Approved parts. \$50,000.00 stock. Over four pounds, catalog, circuits, data, 50c. prepaid (outside U. S., \$1.00). Weekly (new items, test reports), bulletins, 20 wks., \$1.00. Experimenters, 56-page house organ, 25c., prepaid. Kladag Radio Laboratories (established 1926, over 4,000 radiowise customers), Kent, Ohio.

CONVERTER

... BARGAIN!

**110 DC to 110 AC
5 AMP. CAPACITY
3600 R.P.M.**

A small, compact and dependable job; built by best known maker. Has special pulley shaft for simultaneous use as motor if desired. Cost \$140.00. Slightly used. Will sell for \$75.00 cash, or \$15.00 with order and balance C. O. D. Write to Box EFB, care "RADIO," Pacific Bldg., San Francisco.

**FACTORY
REPLACEMENT PARTS**

**FRESHMAN - FREED - EARL
FREED - EISEMANN**

Freshman (G) audio transformer	\$.42
Freshman (Q) audio transformer	.35
Freshman Masterpiece Spider Coils (set of 3) Matches .00025 condenser, (a set)	.15
Freshman Model G-60S condenser block	2.40
Freshman M 60S No. 3914 condenser block	2.75
Freshman N 60S No. 4528 condenser block	3.25
Freshman N 60S No. 4832 Power Transformer	4.50
Freshman Q. 8 1/2 M.F. Condenser (filter)	2.25
Freshman Q. and 3 Q. Power Transformer and Choke No. 4421	3.25
Freshman QD Power Trans. and Choke No. 4827	5.50
Freshman A.B.C. Eliminator Cond. Block	1.25
Freshman G 60S Filament Transformer	1.75
Freshman G 60S Plate Transformer	2.25
Freshman G 60S Audio Transformer	.42
Freshman N. & G 60S voltage divider	.60
Freshman double choke for G 60S	1.15
Freed-Eisemann 80 & 85 Volume Controls	.27
Freed-Eisemann 85 Condenser Block	1.35
Freed-Eisemann 80 & 85 Power Transformer	4.50
Freed-Eisemann 70 Condenser Block	1.35
Freed-Eisemann 80 Condenser Block	1.25
Freed Model 55, 56, 78, 79 and 95 small and large knobs	.09
Freed Model 78, 79, 95 Power Transf.	4.65
Earl 31, 32 & 41 Power Transformers	4.65
Earl 22 and 24, Freed 55 and 56 Power Transformer	3.10
Earl 22, 24, 31, 32 and 41, Freed 55, 56, 78, 79 and 95, Freed-Eisemann 57, 60 and 80 double 30 Henry chokes	1.15
Earl 31, 32 & 41, Freed 78, 79 & 95 double Centralab volume control 50,000 ohm	.58
Earl 22 & 24, Freed 55 & 56 double Centralab vol. control 250,000 ohm	.50
Earl 22, 24, 31 & 32, Freed 55, 56 & 78, Freed-E. 8, 9, 11, 57, 60, 66 friction drives	.15
Grebe 1 M.F. 300 volt condenser	.20
Grebe 1/2 M.F. 300-volt Condenser	.12
Grebe Super Audio Transformer	1.25
Grebe Binocular R.F. Coils (set of 4)	.75
Grebe 125 mil. double chokes	1.65
Grebe Tone Control	.85
R.C.A. Model 17-18 & 33 Power Transformer	3.25
R.C.A. Double 30 Henry Choke	.95
R.C.A. No. 18 Audio Transformer	.50
R.C.A. & A.K. line toggle switches	.10
Wire wound spaghetti covered grid suppressors 500, 750 & 1000 ohm doz.	.60
B. Eliminator transformer for replacement in any B. eliminator using 280 rectifier tubes	.98
Replacement audio transformer	.19
High voltage, 2 watt, metalized resistors 1000-15—4700 ohms, a dozen	1.50
Ward Leonard tapped wire wound resistors, 12,300-5, 135-10,000 and 7,900 ohms, a dozen	2.10
Eby Bakelite binding post marking Long Ant.-Gd-Speaker, a dozen	.40
Four gang Temple .00035 condenser	1.25
Carbon Pigtail Resistors in values of 130, 375, 500, 2000, 10,000, 20,000, 25,000, 50,000, 70,000, 100,000, 250,000 ohms, a dozen	1.00
2 meg. metalized grid leaks, a dozen	1.00
Eight-foot phone cards	.16

TERMS: 20% with order, balance C.O.D. on orders over \$5.00.

**Freed Radio Sales and
Service Co.**

16 Hudson Street New York City

“SOUND WAVES”

World's Only Talking Picture Magazine

announces the opening of a

RADIO DEPARTMENT

Devoted to the Science as It Relates to the Motion Picture Industry

This magazine, published monthly, contains in each issue a complete digest of the important news events throughout the world of talking motion pictures.

Profusely illustrated, and featuring articles of both technical and semi-technical nature, it is recognized today as the supreme authority on sound.

If you would keep abreast of the times and be “in on the know” of this new science, and its relative branches, such as Television, subscribe NOW. You won't regret it.

Price \$1.00 per year Sample Copy 10c

Sound Waves Publishing Co.

CEDRIC E. HART, *Editor*

1040 No. Las Plamas

Hollywood, California



(Note: The Spanish edition, “ONDAS SONORAS,” also published monthly, at the same price, circulates throughout the Latin Americas.)

RADIO

THE NATIONAL TRADE MAGAZINE

REG.
U. S. PAT. OFF.

SERVICE MAN'S SECTION

SENT TO ALL SUBSCRIBERS TO "RADIO" AS PART OF YOUR SUBSCRIPTION

Application of *Filter* Circuits to the *Suppression* of Radio *Interference**

By L. R. KNERR

FILTER circuits may be used for the suppression of radio interference in two general cases. The first, and most desirable, consists of the application of a filter at the interference producing apparatus. The second case, and usually the simpler, is the application of a filter to the power supply of the receiving set. Obviously, this latter case is effective only when the set is a-c operated and is receiving the interference through its power supply leads.

The filter circuits applicable in the two cases above may also be divided into two groups—the first of these are tuned circuits designated to pass frequencies below a certain value, and therefore called "low-pass" filters, and the second group are simply combinations of reactance "choke" coils and by-pass condensers. The use of filters of the first or "tuned" group is limited since the constants of the filter must be tuned to the external circuit as well as to the internal circuit.

For example, let us apply a tuned filter to the power supply of a receiving set as shown in the circuit of Fig. 1.

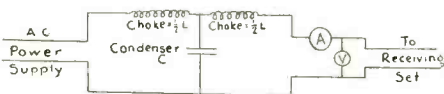

Fig. 1. Filter applied to power supply of receiving set.

With this circuit, the fundamental equations will be

$$L = \frac{Z}{\pi F} \text{ and } C = \frac{1}{\pi F Z}$$

Where:

L = total inductance of the two coils in henrys

C = capacity of the condenser in farads

F = cutoff frequency

Z = load of impedance in ohms = V/A

V = voltage applied to the set in volts
 A = current drawn by the set in amperes

By eliminating πF from the two fundamental equations, we derive a relation between L , C , and Z , as follows:
 $L = C Z^2$

Now, assume that the receiving set takes 0.95 amperes at 115 volts. Then $Z = V/A = 115/.95 = 121$ ohms

Suppose we try $C = 2$ mfd.

$L = 2 \times 10^{-6} \times 121^2 = .0293$ henrys

$F = \frac{1}{\pi Z C} = \frac{1}{\pi \times 121 \times 2 \times 10^{-6}} = 1316$ cycles per second.

While such a filter may be theoretically correct, the inductances required are large and will contain a certain resistance. This resistance introduces excessive losses and also alters the effect of the filter. As a result, the curve of output to input ratio plotted against frequency for such a single section filter will be somewhat as shown in Fig. 2.

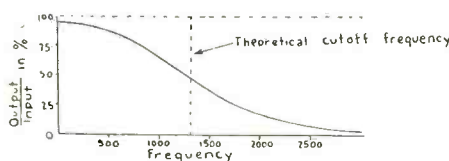

Fig. 2. Cutoff frequency of single section filter.

Therefore, results as good can be obtained more practically by the use of

choke coils and a by-pass as shown in Fig. 3.

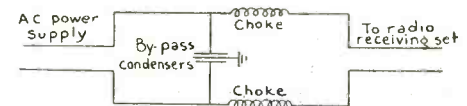

Fig. 3. Practical filter design.

This by-pass and choke arrangement illustrates the second class of filter circuits. The design of such a circuit is not dependent on the external impedance, and therefore these circuits may be used readily in both applications. The following considerations are, however, important:

1. The choke coils must be wound with wire large enough to carry the load current without undue heating or loss. A single layer air core solenoid of about 100 turns is the most desirable form, since it eliminates capacity effect between the end turns, and also allows large heat radiating surface. The solenoid tubing should be fire resistant as a safety factor.

2. The various choke coils should be so spaced and arranged as to prevent mutual induction between them.

3. There should be a choke coil in each power load. This includes any neutral load.

4. The condensers must be designed to withstand the line voltage with a certain factor of safety.

5. Condensers should be placed between each line and a ground on the interference source side of the choke coils.

6. If the installation is under the jurisdiction of a municipal electrical department, that department's requirements must be met.

*Paper presented at October 29th meeting of California Radio Interference Association.

Voltage Regulation*

By C. C. CAMPBELL
Pacific Gas & Electric Co., San Francisco

VOLTAGE regulation begins at the power house. The flow of water has an hourly and daily variation. The generator voltage varies with the load on the machine. The voltage is kept at a predetermined value by sensitive governors. The generators are usually rated at 11,000 volts. The voltage is stepped up at the power houses to 60,000, 110,000 and 220,000 volts for transmission of power over long distances to switching centers, load centers and substation. The voltage changes with the constantly varying load connected to the transmission network. Voltage regulation is accomplished at the receiving end of transmission lines by the use of synchronous condensers. Condensers are usually located near load centers where the various transmission lines converge.

The voltage is again stepped down at distribution substations to 11,000, 4000 and 2300 volts for delivery to cities, towns and rural territory. On each distribution line there is an automatic voltage regulator. These regulators

maintain a constant voltage at the station or at certain points along the line. Beyond the distribution substation no further automatic voltage regulation is economical. It is necessary to maintain a higher voltage at the substations to give satisfactory service near the end of the distribution lines.

The voltage is again stepped down through distribution transformers for use by the various consumers. Here again the varying load will cause changes in voltage.

Due to different voltage rating of various makes of receiving sets, dealers should test line voltage, particularly when installing a set in any neighborhood where line voltage is not approximately known. If a higher voltage than the rated receiver voltage is found, a series resistance should be installed. If low voltage or a fluctuating voltage is found, he should notify the local office of the power company. A recording voltmeter chart will show the voltage at each instant during a 24-hour period.

Fading is sometimes caused by the turning on or off of some electric ap-

pliance. This is not usually caused by variation in voltage but to a change in resonance of the house wiring. The broadcast signal is picked up by the house wiring and carried to the set through the power supply wires or through the coupling between the house wiring and the lead in. If the main source of signal strength is from either of these two sources, a change in the natural frequency of the house wiring will affect the volume. This condition would tend to show an inefficient aerial and ground system. The trouble may be corrected by tuning the house wiring to some different natural frequency, by grounding the neutral service wire at the electric meter or by installing a more effective outside aerial.

In the vicinity of street car lines, fading will sometimes be noticeable. It is thought this is caused by tuning of the trolley system as the cars pass various locations. The trolley wire acts as a carrier for the high frequency currents which are drained off through the street car motors to ground. No effective solution for this condition is known at the present time.

* Paper presented at October 28th meeting, California Radio Interference Association.

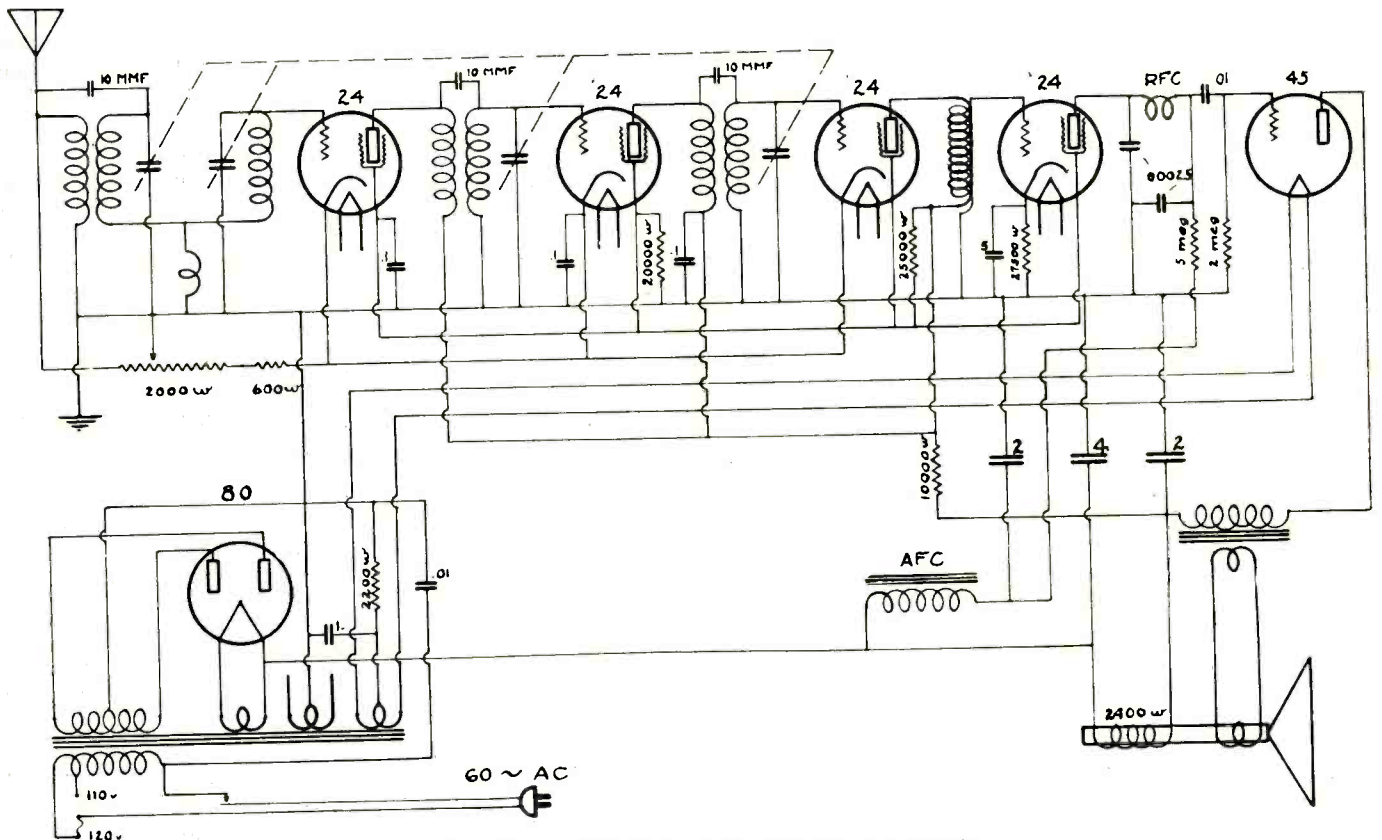

Radiette Model F-14, Keller-Fuller Mfg. Co., Los Angeles

Q & S

That Service Men Are Likely to Meet in Forthcoming Examinations

By J. EDWARD JONES

President, Pacific Radio Service Managers' Association

Q. Describe briefly the new pentode tube and give some of its advantages.

A. It is a so-called five-element tube. The a-c type is similar to the '24, except that the grid is also screened by an additional element called the space charge grid. Its principal advantage in an ordinary circuit is a higher amplification factor than the '24, but with lower plate resistance. It is possible that new circuits will be developed utilizing this tube to much greater advantage.

Q. State one very reliable method for eliminating so called "cross-talk" interference, and state what effect this type of interference has upon the apparent selectivity of the set.

A. Many ingenious methods have been tried to eliminate this type of interference, differing in different localities, and on different sets. In some cases a very long, shielded antenna and ordinary line filtering will be sufficient, and in some cases a proper grounding of the neutral of the power supply will stop it. The best method seems to be a tuned rejector circuit in the line, tuned accurately to the interfering station with proper by-passing. This effect has nothing to do with the selectivity of the set. It is the super-imposing of one carrier directly upon another.

Q. How would you put a load on a complete power pack condenser bank so as to make a rough check of its condition, the pack being a part of a fully assembled set?

A. Remove all tubes from set except rectifier and turn the set on. This will put an excessive voltage across the condenser bank, usually sufficient to show up leaks or defects. The plate current should be watched on the rectifier plates, as excessive current will denote leaks or other defects.

Q. You have a set which is known to be in good condition. It uses one power tube. After placing tubes in sockets, you find the power tube has low grid bias. What would you assume to be the trouble, and why?

A. The assumption would be a power tube with low emission, therefore low plate current. Still assuming that power tube bias was obtained in usual manner

with plate current flowing through bias resistor, it is obvious that subnormal plate current would create low voltage drop, therefore low bias voltage.

Q. Give approximate method of computing wattage of a receiver where a-c input current is known.

A. Obtain wattage of each tube filament by multiplying current by voltage. Multiply plate current of each tube by plate voltage of that tube. Compute current drain through bleeder and obtain wattage as before. The sum of all these will approximate the wattage of the set.

Q. If there is an open in the plate circuit of the rectifier tube in a receiver or if the rectifier tube is otherwise inoperative, what effect would this have upon the filament voltages in the set itself?

A. The general effect is that all filament voltages would be high, depending upon the overload factor of the filament transformer. The load of the plate circuits, which in this case would be zero, is a considerable portion of the total load on the transformer.

Q. Given a power unit with two chokes or one choke and speaker field in series with a filter condenser between the junction of the two and the common side, what would be the effect on the voltage output and the reproduction if this condenser went open?

A. The plate voltage would drop considerably and the reproduction would be accompanied with abnormal hum.

Q. If you had some shorted turns in the primary of a power transformer which raised the voltage on all secondaries on account of change in ratio, how would you make an emergency repair?

A. Use a suitable wattage resistor in the primary circuit to cut down the input voltage until the voltage delivered by secondaries was of correct value.

Q. Given a dummy tube and a neutralizing wrench or screwdriver, how would you neutralize a set in the customer's home without a modulated oscillator?

A. Tune the set to good, steady broadcast signal with considerable volume, one playing dance music, if pos-

sible, as that type of music is steadier. Take out one r-f tube, insert dummy tube, and adjust neutralizing condenser of this stage until no signal or a minimum volume is heard. Then replace regular tube and repeat operation for each stage. If this procedure is followed, fairly satisfactory results can be obtained without additional equipment.

Q. On a home recording device, name a simple method of proving if everything is satisfactory for recording.

A. Play any ordinary record. If volume and tone is normal, then the pick-up and all major parts are in condition for recording. The change-over switch is the only part not checked by this simple test.

Q. If a single '45 tube draws 30 mills and it has a grid filament bias of 50 volts, what is value of resistor connected in conventional manner between center of filament and ground.

A. From Ohms Law: $R = E \div I = 50 \div .03 = 1666.66$ ohms.

Q. What would be the observed effect on the operation of a receiver having one or more of the equalizing condensers out of resonance.

A. The most obvious effect would be unusually broad tuning. In some cases the two-peak effect would be produced, but always a loss of volume and sensitivity.

Q. On a phonograph combination, the reproduction of records is very weak. Give some of the causes for this.

A. Open lead at detector plate, open ground to pickup terminal, open or defective switch, armature of pickup out of adjustment, or possible defect in wiring pickup circuit.

Q. What are the principal causes for distortion in an electromagnetic pick-up?

A. Worn needle, defective clamping, excessive tension on tone arm or armature.

Q. State various reasons why a dynamic speaker gives poor reproduction when set and tubes are known to be good.

A. Defective cone, cone out of adjustment, possibly loose voice coil, or defective field. If a-c operated, possibly worn-out rectifier.

dawn and to the right. To properly peak the intermediate stage, a 175-kc oscillator and output meter should be used. Grid bias for the i-f tube is taken from the drop through a 60-ohm resistor plus three volts from the resistor on the negative end of the voltage divider. Plate voltage is supplied from the high voltage line, at the low potential end of the speaker.

The second detector operates with about twenty volts on the grid when no signal is tuned in, this voltage being supplied by the drop through a 35,000-ohm resistor in the cathode circuit. The usual .001 μ f r-f filter condenser and r-f choke is used in the detector output circuit, with another .001 μ f filter condenser at the other end of the choke. The second detector plate is supplied from the main high voltage line, through a 25,000-ohm resistor which drops it to about 225 volts.

An a-f transformer couples the second detector to the push-pull audio stage. Grid bias is obtained from the drop in an 800-ohm resistor between the center-tap of the '45 tube filament winding and ground. The plate voltage is taken from the positive line after it has passed through the filter choke and the speaker field winding.

The power supply system contains a transformer with four secondary windings; one for the heater type tubes, one for the '45 power tubes, one for the rectifier filament and one for the high voltage. After being rectified the voltage is filtered through an a-f choke which has a 2 μ f condenser at the high potential end, a 3 μ f condenser at the low end and a .09 μ f condenser shunted

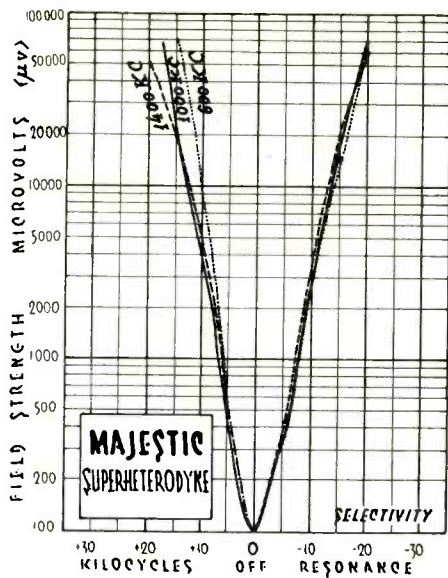

Majestic Superheterodyne Selectivity Curves

THE selectivity curves for the little Majestic superheterodyne are rather startling. In the first place they are almost constant over the entire band, and in the second place they show selectivity on all frequencies that is very nearly as good as the average receiver on 600 kc, which is usually the most selective frequency. The sheet of graph paper wasn't large enough to get the curve across the 30 kc vertical. The ratio at 20 kilocycles above resonance on the 1400 kc curve, however, is 520 to 1.

around it. The speaker field winding constitutes the second a-f choke and a 1 μ f condenser is connected across its low potential end and ground. From here the voltage goes into a voltage divider, the terminals of which have already been explained.

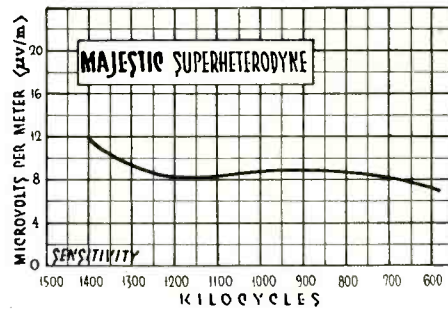

Fidelity Curve of Majestic Superheterodyne

THE fidelity curve of the Majestic superheterodyne shows a drop of 7½ decibels at 60 cycles and one of 19½ db at 5000 cycles. With such great selectivity one would be led to expect that the drop at high frequencies would be enormous. A moment with the slide rule, however, shows that when the voltage ratio is converted to decibels the most that can be dropped due to the cutting of sidebands is a little less than 12 db. Therefore, by building an a-f amplifier with little high frequency drop the total drop is less than that of the average, less selective receiver.

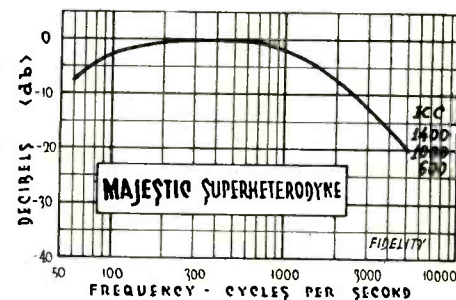

Sensitivity Curve of Majestic Superheterodyne

THE sensitivity of the little Majestic is not what might be expected of a superheterodyne, but this is due merely to the fact that only one intermediate frequency stage was used.

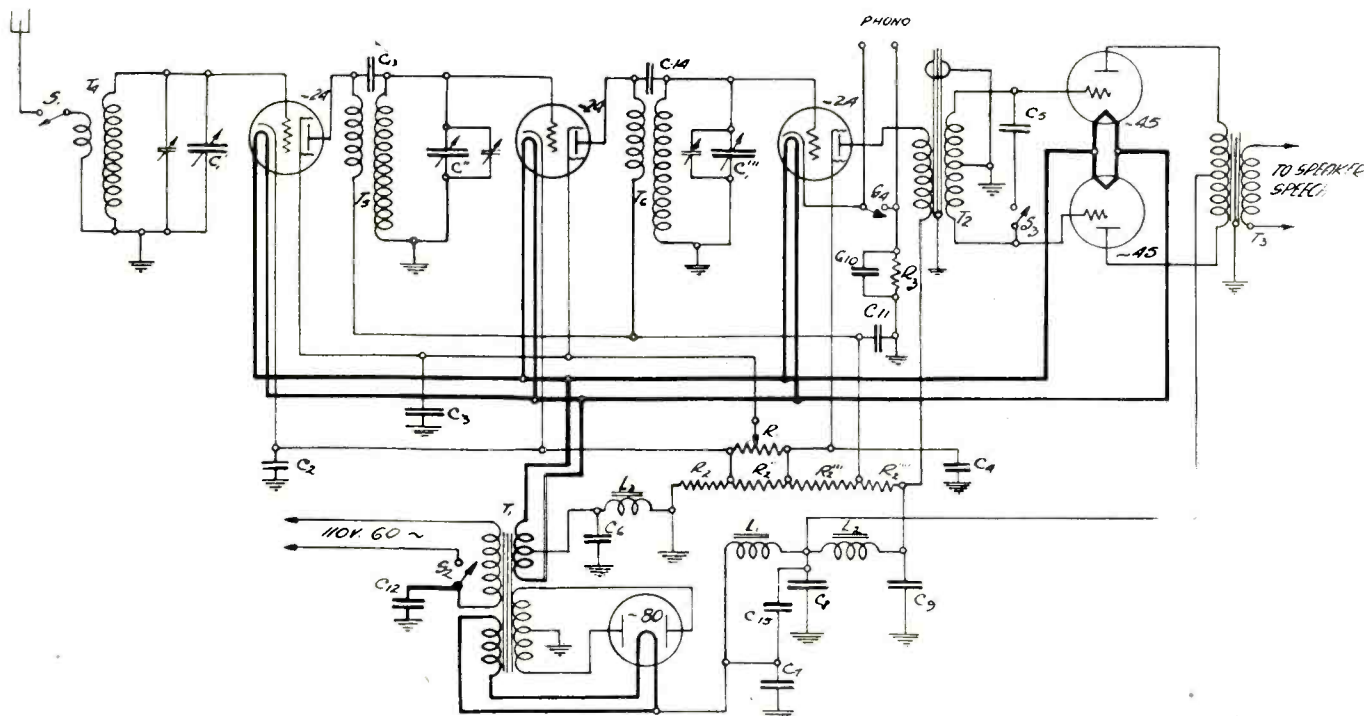

Circuit Diagram of Clarion Junior

Circuit Analysis of Edison R-6 and R-7

THESE receivers employ three screen grid r-f stages, a combination detector and automatic volume control in which a '27 tube is used, two resistance coupled a-f stages employing '27 tubes, and a push-pull power stage with two '45s. The rectifier is an '80.

A single pole switch in the antenna circuit shunts a 20-ohm resistor across the antenna and ground for reduced sensitivity, or local reception. The antenna is coupled capacitatively to the first inductance. There are three tuned circuits ahead of the first r-f tube, the first two of which serve as a pre-selector system and the third as the tuned grid circuit of the first screen grid tube.

The cathode of the first tube is grounded through a resistor which supplies the grid bias, but the grid returns to ground through a rather indirect route. It passes first through a 100,000-ohm isolating resistor, used to force the r-f currents to ground through the condenser which by-passes it, then through

another isolating condenser and finally through a two-unit voltage divider arrangement which is connected between the detector grid and the cathode-plate tie-up. There is an audio frequency voltage across this divider, the amplitude of which determines the amount of additional bias supplied to the grids of the r-f tubes through the line just traced.

The screen grid of the first tube is supplied with direct current from the power supply after passing through an isolating resistor which is by-passed through a .1 μ f condenser. The plate is fed direct from the power supply. Inductive coupling is used between stages, the primaries of the r-f transformers being divided into two sections with a small semi-variable condenser across one section for the purpose of tuning the primary impedance to that of the tube.

The grid circuits of the second and third r-f tubes are similar to that of the

first except for the first isolating resistor which appears in series with the first grid. The grid of the third tube, instead of returning to ground through the whole a-f voltage divider, passes through an isolating resistor of its own and is tapped into the junction between the two sections of the divider. The bias on all three r-f tubes varies with the volume. The second and third screen grids are fed from the same source as the first, although they have no isolating resistor.

The detector coupling unit consists of an r-f transformer, the secondary of which is coupled, through a condenser bank, to what might be considered the primary section of an auto-transformer. The complete winding of this auto-transformer comprises the grid inductance of the detector, and is untuned. The resistor between the grid return lead and the detector coupling condenser is a part of the detector output filter.

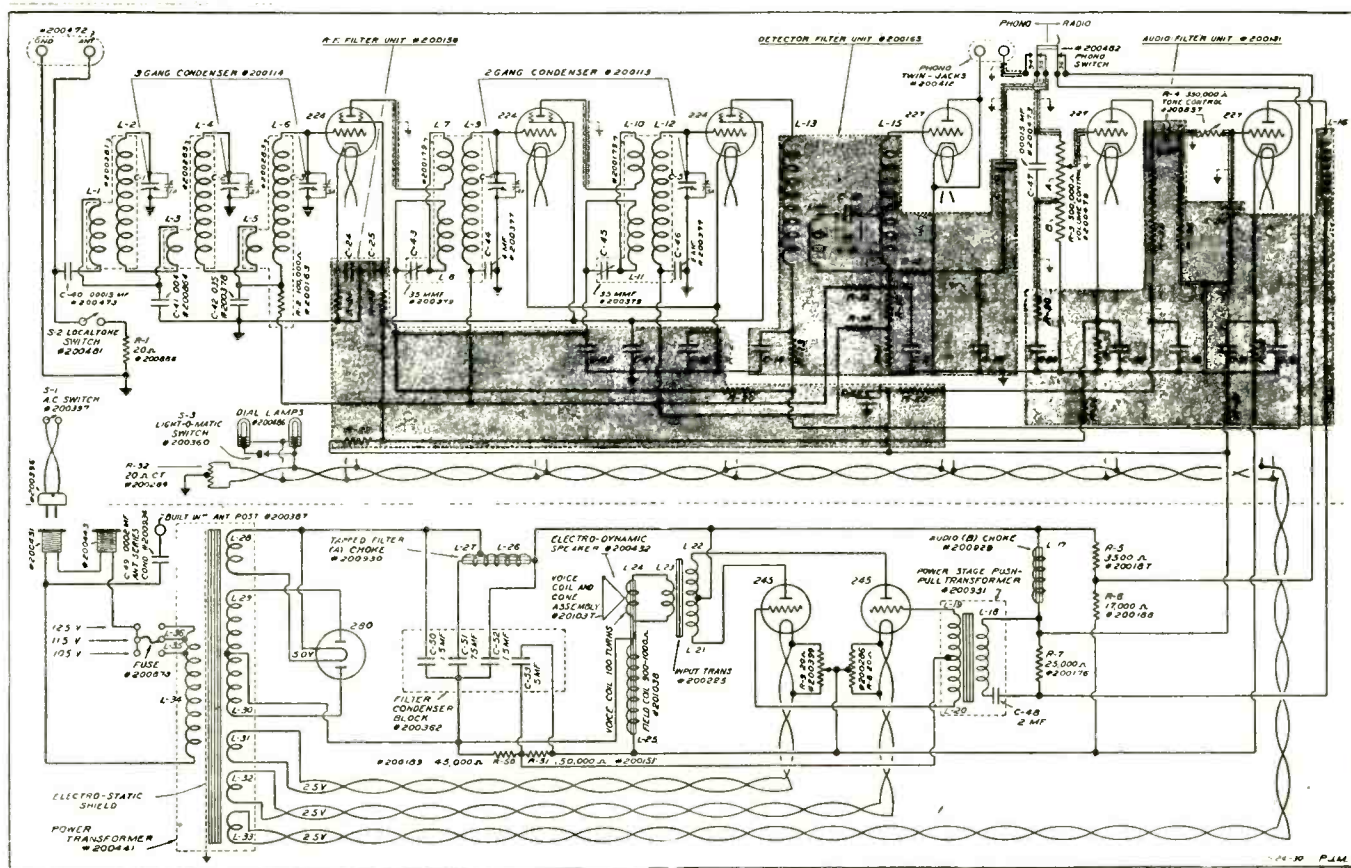

Circuit Diagram of Edison R-6 and R-7

The detector plate and cathode are tied together and are supplied with no d-c potential. This system, of course, entails quite a loss in signal voltage, making it necessary to use three a-f stages instead of one or two.

The phonograph switch is inserted at this point, connecting the pick-up across the grid of the first a-f tube and ground and opening the plate circuit to the r-f tubes for phonograph reproduction. The grid resistor of the first a-f tube is used as the volume control, and a fixed tap is made in it from which a resistor and series condenser are connected to ground to balance the tone. The second audio stage is straight resistance-capacitance coupling with a tone control added. Each of the first two a-f tubes has its own cathode resistor, the drop through which supplies the necessary grid bias to the tube. The resistor between the cathode of the first a-f tube and the screen grids of the three r-f tubes is merely a bleeder to stabilize the screen grid voltage.

The transformer in the power supply has five secondaries; one for the rectifier filament, one high voltage, one for each '45 power tube and one for all the heater type tubes. After the high voltage has been rectified it passes into the tap in a three-terminal choke, one section of which is used to buck out the 60 and 120-cycle a-c remaining. A filter condenser is shunted across each terminal and the negative end. The high voltage at this point goes through the output transformer primary to the power tube plates. The same line continues to a junction between an a-f choke and a 3500-ohm resistor, the former supplying first the screen grids and the plate of the first a-f tube, then after being reduced in a 25,000-ohm resistor,

the plate of the second a-f tube. The 3500-ohm resistor mentioned above is one section of a voltage divider, its negative end, or the junction between the two resistor units in the divider, supplying the plate potential for the r-f tubes. The second unit, of 17,000-ohms, is a bleeder. The speaker field winding is connected in series with the negative lead, serving both as an a-f choke and as a reactor to drop enough voltage for biasing the grids of the power tubes.

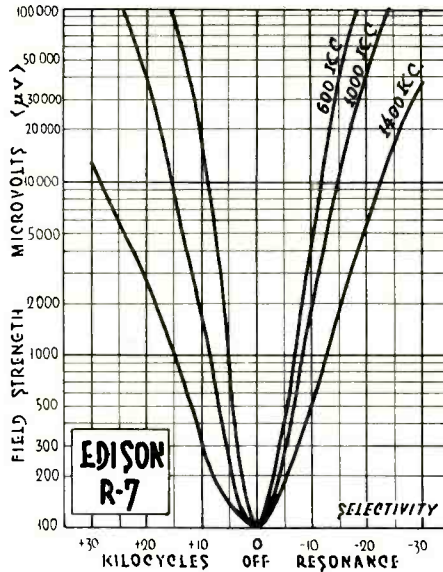

Edison R-7 Selectivity Curves

THE Edison R-7 receiver is selective enough on 1400 kc to require a field strength from an interfering station of 130 times the field strength of the selected station for complete interference. On the negative side, *i. e.*, from 1400 kc down, the receiver is slightly more selective, the ratio between interfering field strength and strength of desired signal being 230 to 1 at a distance of 30 kc off resonance.

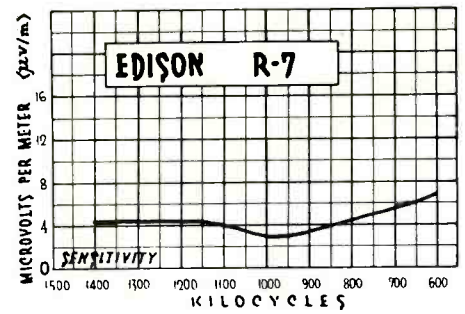

Edison R-7 Sensitivity Curve

THE sensitivity of the Edison R-7 is very good, ranging from 3 microvolts per meter at its best point to 7 microvolts per meter at the low frequency end of the scale. It is most sensitive at about 1000 kc. This curve tells just how much input r-f voltage is required for the receiver to have an output of 50 milliwatts.

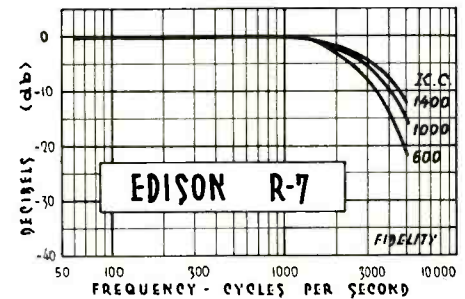

Edison R-7 Fidelity Curve

THE fidelity curve of the Edison R-7 is most unusual, especially on the bass end. The curve is a straight line right down to 60 cycles, meaning that the bass notes of from 60 to 100 cycles per second, or vibrations per second, as they would be termed in music, are reproduced with the same strength in the loudspeaker as the notes in the middle of the register. The highs begin dropping at 1000 cycles, going down to 13 decibels, or sound units at 1400 kc and 22 db at 600 kc. The difference is due to the cutting of sidebands with the greater selectivity noted at 600 kc.

Radio Broadcast Reception and the Operation of Electric Railway Systems*

By E. W. COOK
Pacific Electric Railway Company

ELECTRIC railways have, in addition to the radio frequency sources of radiation produced by the operation of other utilities, certain inherent characteristics that place them in a separate classification. These sources of radio interference as produced by the normal operation of the Pacific Electric Railway Company's lines in Los Angeles, Orange, Riverside, and San Bernardino counties may be briefly outlined as follows:

As the company purchases all of its electrical energy it does not have any generating equipment to cause radio interference.

Following the path of the energy through the railway system, the first possible source of high frequency radiation is the 16.5 k. v. transmission lines connecting the various substations. These lines were built many years before radio appeared on the scene and it has since been found desirable from a radio viewpoint to change some of the details of the construction standards. These details involve increasing the separation between certain parts of the line hardware and the bonding of other parts.

The next source is the substation a-c to d-c conversion equipment. The only important source of interference in this equipment is the sparking at the d-c

commutator brushes of the machines that were designed before commutating poles were adopted as standard.

Under the widely fluctuating load demands of this company's system a maximum of routine maintenance effort does not appreciably reduce the amount of this interference and still more discouraging is the failure of all attempts so far made on this system to prevent the radiation of this high frequency energy by the overhead trolley feeder system.

Experiments were made with various combinations of condensers connected between the generator terminals, brush arms, etc., and an auxiliary set of brushes was so installed that condensers could be connected across the armatures

* Paper presented at October 28 meeting, California Radio Interference Association.

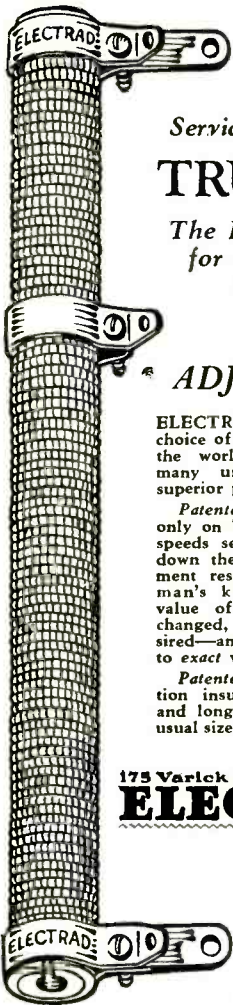

SPEED

Service Work With TRUVOLT

The Better Resistor
for Replacement
Purposes

IT'S ADJUSTABLE

ELECTRAD Resistors are first choice of service men all over the world because of their many unique features and superior performance.

Patented sliding clip, found only on TRUVOLT resistors, speeds service work and cuts down the number of replacement resistors in the service man's kit. The resistance value of each unit can be changed, taps added, as desired—and speedily adjusted to exact values.

Patented air-cooled construction insures stable operation and longer life. Made in all usual sizes and wattage ratings.

175 Varick St., New York, N.Y.
ELECTRAD
INC.

Write Dept.
DS-11 for
TRUVOLT
Literature

U. S. Pat. 1676869
and Pats. Pend.



HEADQUARTERS for CONDENSERS

*That Simplify
Replacements
and Service Work*

Hammarlund Condenser quality is recognized by radio experts the world over.

Back of Hammarlund workmanship are more than 30 years of engineering precision devices for telegraph, telephone and radio work.

Whatever variable condensers you need, for tuning, balancing, or other circuit control, you can rely on Hammarlund. They simplify replacements and service work.

Write Dept. DS-12 for
descriptive literature

HAMMARLUND MFG. CO.
424-438 W. 33rd St., New York

For Better Radio
Hammarlund
PRECISION
PRODUCTS

short circuited coils at the moment the current in these coils was broken at the main branches.

A further test was made with the series field connected as a choke between the armature and trolley feeders. This slightly reduced the interference but cannot be permanently used on account of insufficient insulation on the series field coils.

The next point of possible trouble is the contact between trolley wire and trolley wheel. This produces by far the most severe and annoying interference of all of the varieties originating on this company's system.

Due to the many variables involved and the distances that this interference travels along the trolley feeder system, its true source was not determined until special tests were made under favorable conditions when it was found to be produced by the interruption of the small amount of current flowing through the contact when the main control, lights, heaters, and compressor motors were off.

This circuit includes a trolley dewirement indicating relay, commonly known as a trolley buzzer relay, and the unavoidable insulation leakage current, the total being of the order of one-tenth of an ampere. The origin being at the trolley, which serves as a radiating antenna, attempts to mitigate the interference by installing chokes, condensers, etc., on the cars have proven to be of little value. The only solution of the problem seems to be to prevent the sparking at the trolley wire by using a sliding type of contact device.

This company has experimented with such contact devices, known as trolley shoes, but to date has not found one that satisfactorily meets all of the operating requirements.

The car control equipment, main motors, auxiliary motors, and rail contact all produce a small amount of interference which has not been found to be serious on this system.

Another possible source of interference is the private telephone system. The only case so far reported was corrected by installing a battery operated ringer in place of the offending ringer operated by trolley current.

The remaining source to be mentioned is the signal system. All a-c operated signals do not inherently cause radio interference, but the d-c operated highway crossing signals, known as automatic flagman or wigwags, were a serious source of interference until condensers were installed across the operating magnet control contacts. A total of approximately 600 wigwags have been so equipped and complaints chargeable to wigwags have practically ceased to be reported.

Tell them you saw it in RADIO



AUTO-PAL

\$65.00 Complete

With tubes, speaker, batteries, etc.

Write today for exclusive
agency on this big seller

PREMIER ELECTRIC COMPANY

1803 Grace Street Chicago, U.S.A.

Your Radio Needs AMPERITE Voltage Control

Get from your electric radio the quality that was built into it. AMPERITE automatically regulates line voltage fluctuations. Provides stable, constant voltage supply. Saves tubes. Trouble-proof—long lasting.

Greatly improves any electric radio. Many of the better-known makes are equipped for AMPERITE.

Demand it when you buy a radio, include it when you build. No radio is modern without it. Install the new AMPERITE in every set you service.

FREE—Useful AMPERITE Bulletin and list of AMPERITE-equipped radios.

Write Dept. DS 12

AMPERITE Corporation
561 BROADWAY, NEW YORK



AMPERITE
Self-Adjusting
LINE VOLTAGE CONTROL

BINDERS

For preserving your copies of "Radio"
\$1.00 Postpaid

PUBLISHERS OF "RADIO"
Pacific Building San Francisco

SHORT WAVES

For only

\$5.00

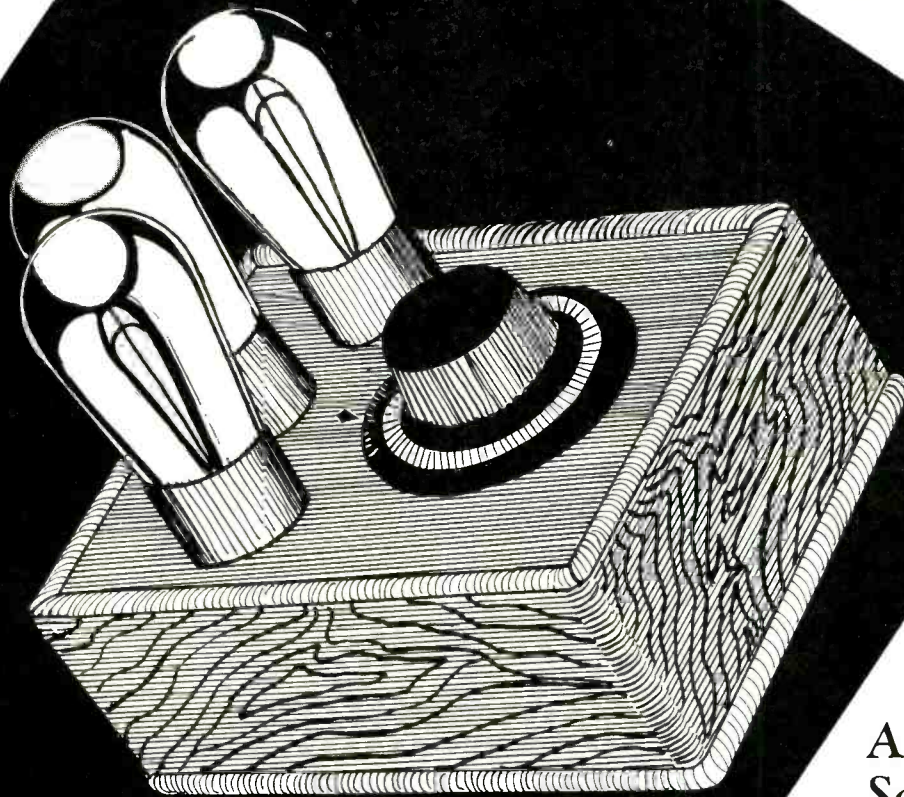

*A Little
Box of
Magic*

**A Big
Sales
Builder**

BRING in short waves on a regular broadcast receiver and you will fascinate your customers. Do it with apparatus that costs very little and you will make them "buy now." The two chief objections to short-wave converters, first, that they don't work, and second, that they cost too much even if they did work, have been removed. Radio World, the first and only national radio weekly, will be glad to lay the information before you that shows how readily success is achieved.

Reasons Why It's Vital to You!

- 1** You can make the sale of a broadcast receiver an easy matter if you can show the customer you can inexpensively equip him for short-wave reception as well.
- 2** You can demonstrate short-wave reception, an enticing novelty, instead of always reproducing broadcast transmission, to attract attention of passersby, and make them goers-in.
- 3** You can put in your window a cabinet only $7\frac{3}{4}$ x $5\frac{3}{4}$ x $2\frac{3}{4}$ in., and truthfully announce that this little Box of Magic brings in short waves on the speaker, when used with a broadcast set.
- 4** If you have customers who complain of being in dead spots or in static belts—arguments manufacturers particularly must meet in export trade—you can supply them with something that will make the broadcast set (which you are most anxious to sell) really operative.

Let RADIO WORLD Help Boost Your Sales!

Each week *Radio World*, now in its *ninth* year, is published. It contains valuable data on how to service receivers, including diagrams of the 1931 sets, with helpful textual expositions to assist service men. Send \$1.00 for an eight-weeks' subscription (the regular price) and get FREE the November 8, 15 and 22 issues that contain the full data on the short-wave converter.

RADIO WORLD, 145 West 45th Street, New York, N. Y.

Enclosed please find \$1.00 for which enter my subscription for RADIO WORLD for eight weeks (eight copies, one copy each week, beginning at once) and send me free, as a premium, the November 8, 15 and 22 issues, explaining all about the \$5 model 3-tube short-wave converter.

Name

Address

City..... State..... (RSF)

"Official" RADIO SERVICE MANUAL

and
Complete Directory of all
Commercial Wiring
Diagrams

IN LOOSE-LEAF
FLEXIBLE, LEATHERETTE
BINDER

OVER 1,000 ILLUSTRATIONS, DIAGRAMS, Etc.
352 PAGES 9" x 12"
Weight 2½ lbs.

HUGO GERNSBACK, *Editor*
CLYDE FITCH, *Managing Editor*

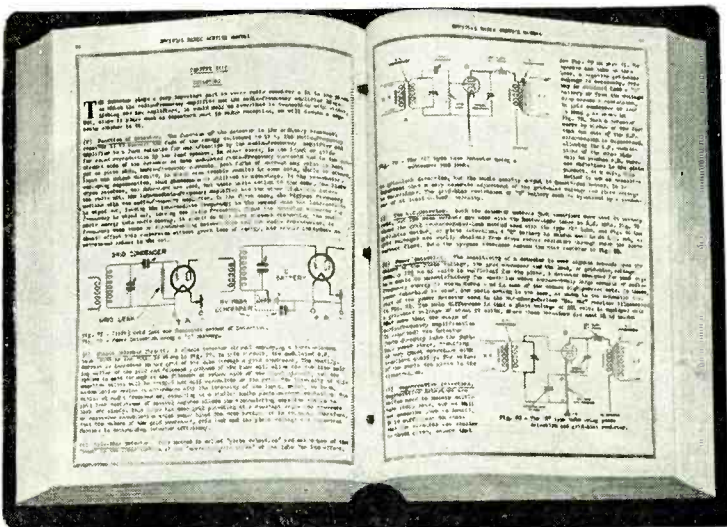

Prepared Especially for the Radio Service Man!

NEVER in the history of radio has there ever been published a service manual, so complete, as this new OFFICIAL RADIO SERVICE MANUAL. It is a veritable encyclopedia of service information—worth several times its price. It is invaluable not only for the Service Man, but for everyone interested in radio.

THE BIGGEST RADIO VALUE IN AMERICA TODAY!

\$3.50 A COPY

There has been collected for this manual wiring diagrams and data of nearly every commercial set, of which there is any available record, manufactured since 1927, and many earlier ones.

The OFFICIAL RADIO SERVICE MANUAL is made in loose-leaf form in a handsome, durable, flexible leatherette binder and contains 352 pages of the large size, 9 x 12.

Additional service data for new receivers, as they appear on the market, will be published and supplied at a trifling cost so that the MANUAL may be kept up-to-date at all times. But that is not all.

You simply cannot realize what a tremendous work this is until you have held a copy in your hands and have gone through its 352 pages. Over 1,000 illustrations, diagrams, etc.

WHAT THEY SAY

NOTHING CAN COMPARE WITH IT
I have received my copy of the OFFICIAL RADIO SERVICE MANUAL. I expected it would be good for I think you know as much as any of them what the average radio man wants, but I'll wager not very many expected to receive a book comparable to this one. I think you deserve a lot of credit for being the first to put out a real service manual that the amateur or professional can make good everyday use of. It's a good practical book and one that every service man will be proud of.—E. D. HANA, Haslett, Mich.

BEST BOOK IN THE FIELD
I received your book OFFICIAL RADIO SERVICE MANUAL and I find it is as yet the best book I have found in this field of radio. You are well justified in that this is the peer of service manuals. I wish you all the success possible in the publishing of future books on radio. Thanks.—WILLIAM E. BROWN, Brown Radio Service, 1010 Buckingham Street, Toledo, Ohio.

WORTH A GREAT DEAL MORE
Received your copy of OFFICIAL RADIO SERVICE MANUAL and am greatly pleased with same. It is worth a great deal more than it costs.—HAROLD AIGUIER, 41 Rutland Ave., Arlington, N. J.

"SHE IS A BIRD"
Just to let you know we received my MANUAL this A.M. and—OH BOY!! She is sure a BIRD! You sure did strut your stuff, AND HOW!!—Y. H. HERNDON, Herndon's Radio Shop, Odon, Indiana.

EXTREMELY PLEASSED
I acknowledge receipt of the OFFICIAL RADIO SERVICE MANUAL and I am extremely pleased with it.—EDW. JOHN SMITH, 337 E. 26th St., Erie, Penna.

A VERITABLE GOLD MINE
I received the OFFICIAL RADIO SERVICE MANUAL. I am well pleased. It is a veritable gold mine for the Service Man.—EUGENE BINFORD, Arkansas City, Kansas.

MAGNIFICENT
Received my copy of the OFFICIAL RADIO SERVICE MANUAL this A.M. "She is what you call him? Magnificent! Exquisite!" A timely aid for the troubled sets.—E. BOICE, 1118 W. Dauphin, Philadelphia, Pa.

FINEST THING
Just received the RADIO MANUAL. It sure is the finest thing I have seen.—E. J. SCHWARM, 465 Eddy Road, Cleveland, Ohio.

IT ASTOUNDED THEM
Everywhere I have exhibited the MANUAL it has taken the boys by surprise and its completeness has astounded them. For instance, Saturday morning last I had occasion to run into the service plant of the Mackenzie Radio Corp., New York District Distributors for Zenith Radio, in connection with replacement units, and when I showed the Service Manager, Mr. Wandell, the MANUAL, he was agreeably surprised and called the men to see the work. Delightfully yours, and always a booster for Gernsback Publications, of which I read practically all, and study them.—IRA C. HALDERMAN, 44 Leroy Place, Ridgewood, N. J.

SERVICE INFORMATION

The OFFICIAL RADIO SERVICE MANUAL contains also a most comprehensive instruction course for the radio Service Man, giving practical information from every angle on how to service the set. Here are only a small number of the articles mentioned:

- Amplifiers (Audio and Radio)
- Automotive Radio
- Antennas
- Condensers
- Detectors
- Eliminators
- Meters
- Power Supply Systems
- Radio Phonograph Equipment
- Resistors
- Short-Wave Sets
- Speakers
- Tubes

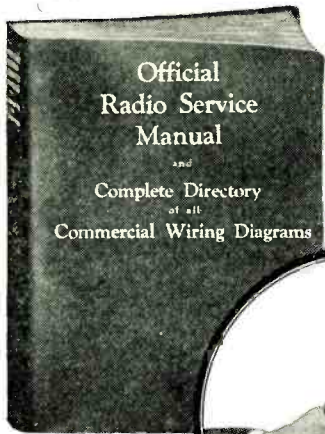

MAIL
COUPON
TODAY—

PUBLISHERS OF "RADIO"
428 Pacific Building, San Francisco, Calif.

R-11

As per your special offer, I enclose herewith \$3.50 for which you are to send me postpaid, one copy of the OFFICIAL RADIO SERVICE MANUAL.

Name

Address

City..... State.....

NEW CROSLLEY adds three Outstanding Models to a Successful Line



On Mantel



On Table



Next Easy Chair



The Crosley NEW BUDDY BOY

Now comes this amazing new radio sensation—The Crosley BUDDY BOY—suitable for endless uses in the home—suitable for use in every room of any house—delivering ultra-performance on all not too far distant stations—incorporating all of the most recent Crosley radio developments—and sold complete with tubes at an astonishingly low price—and only 15½" high, 17" wide, 9½" deep.

The cabinet introduces new beauty in sets of this type—and an entirely new method of construction—a one-piece cabinet without seams, joints, nails or screws. Learn about this new radio marvel now—your Crosley distributor will gladly demonstrate. There's nothing approaching it in the radio world today for only

\$59.50
WITH TUBES

The New Classmate

A marvelous cabinet exactly like the famous Crosley MATE except that it is five inches higher. Contains the same type sensitive and selective receiving set as The MATE and, in addition, incorporates the latest type Crosley moving coil dynamic power speaker. Astonishingly low in price at only

\$85.50
WITH TUBES

The New Administrator

Here is a truly magnificent cabinet of thoroughly modern and special design which houses the same type receiving set and latest Crosley moving coil dynamic power speaker as The DIRECTOR. Has positive automatic volume control and local-distance switch. Priced startlingly low at only...

\$112.50
LESS TUBES

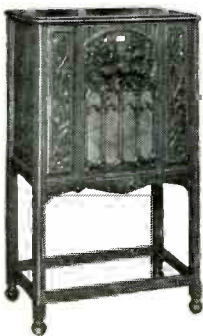

The BUDDY

An exquisite table, mantel or clock type self-contained receiving set, with power speaker, only 15½" high, 15½" wide and 9½" deep, so small in size and light in weight that it is easily moved from place to place. Contains the same type receiving set and dynamic power speaker as The PAL and The MATE. Employs three Screen Grid tubes. Nothing ever equalled it at so low a price.

\$64.50
WITH TUBES



The PAL

A marvelously beautiful cabinet, 25½" high, suitable for use as an end, bedside or occasional table. Contains the same receiving set and dynamic power speaker as The MATE and employs same number and type of tubes. The price is amazingly low for the quality and performance.

\$74.50
WITH TUBES



The MATE

A delightfully designed and executed cabinet that harmonizes with any surroundings in the home. It contains an entirely new receiving set and dynamic power speaker. Employs three type -24 Screen Grid tubes, one type -45 and one type -80. The unusual value of The MATE at the exceptionally low price is self-evident.

\$79.50
WITH TUBES

The DIRECTOR



A particularly beautiful cabinet containing a receiving set employing three Screen Grid tubes type -24, one type -27, two type -45, and one type -80. Positive automatic volume control, local-distance switch and latest type Crosley moving coil dynamic power speaker are features of this set. Astonishingly low in price...

\$107.50
LESS TUBES

The ARBITER



Electrical Phonograph and Radio Combination

A truly versatile instrument that provides complete entertainment for any occasion in the modern home, complete in a cabinet of superlative beauty. The same super-selective and sensitive radio receiving set and moving coil dynamic power speaker as in The DIRECTOR and The ADMINISTRATOR. A marvelous electric phonograph and radio combination for what you would ordinarily expect to pay for a radio receiving set alone.

\$137.50
LESS TUBES

Available with induction type self-starting motor at \$147.50

THE CROSLLEY RADIO CORPORATION
POWEL CROSLLEY, JR., President Home of "the Nation's Station"—WLW
CINCINNATI

Also manufacturers of CROSLLEY Battery Radio Receivers, the CROSLLEY ROAMIO Automobile Radio Receiving Set, and the famous AMRAD RADIO

YOU'RE THERE WITH A CROSLLEY
CROSLLEY RADIO

DOTY W E
RT 6 BOX 786
BATTLE CREEK MICH

R 7

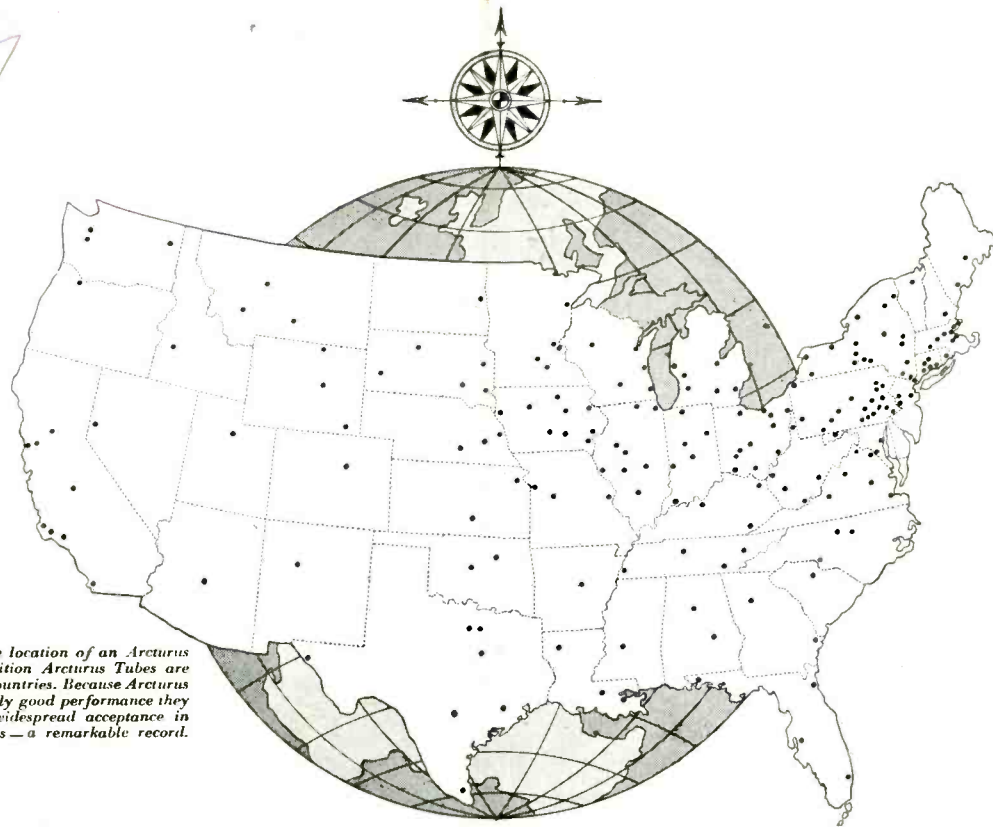

Each dot shows the location of an Arcturus distributor. In addition Arcturus Tubes are sold in 54 foreign countries. Because Arcturus Tubes give unusually good performance they have gained this widespread acceptance in less than two years—a remarkable record.

This **NATIONAL ACCEPTANCE** *is based on* **OUTSTANDING QUALITY**

WHEREVER radio sets are used, Arcturus Tubes have built a reputation for exceptional quality.

Radio jobbers, radio dealers, and the radio listening public know that they can depend on these *Blue* tubes for every essential feature. In quickness of action, clarity of tone, and length of life, Arcturus Tubes meet every demand.

This proved performance under all conditions has gained world-wide distribution and universal acceptance for Arcturus Tubes in a remarkably short time. In every state in

the union, as well as in 54 foreign countries, Arcturus Tubes enjoy steadily increasing sales. Today, Arcturus ranks as the leading unallied manufacturer from the standpoint of volume sales, acceptance and performance of product.

You can safely invest your capital and your time in tubes of such widely accepted quality. Stock and sell Arcturus Blue Tubes and you are sure to satisfy your most critical customers. Get the details from your jobber.

Arcturus Radio Tube Company, Newark, N. J.

ARCTURUS

"The TUBE with the

LIFE-LIKE TONE"



1088 Howard Street, San Francisco, Calif.
201 Calo Bldg., Los Angeles, Calif.

West Coast Representatives
UNIVERSAL AGENCIES

1914 E. Sprague Avenue
Spokane, Washington

PRINTED BY
THE JAMES H. BARRY COMPANY
SAN FRANCISCO, U. S. A.